



ULTRA HIGH VACUUM COMPONENTS

超高真空用部品

『人類社会の進歩発展に貢献する』

“Contribute to The Advancement of Society and Humankind”

これは京セラ株式会社の経営理念の一節です
社会のインフラ整備や未来に向けた科学研究の一翼を担うことで
次の世代の生活を豊かにする
それが私たち京セラ株式会社の使命です

This is a passage from the management philosophy of Kyocera Corporation.
Kyocera's mission is to enrich the lives of the next generation by contributing
to infrastructure development and undertaking scientific research for the
future society.

半導体製造装置 Semiconductor Processing Equipment



各種端子部品
Feedthroughs

自動車 Automotive



EV リレー部品
EV Relay Parts

LNG 関連



電力・エネルギー Energy

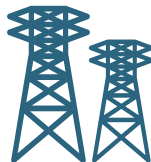

航空・宇宙
Aerospace



研究機関
R & D



加速器用部品
Accelerator Parts

通信

Communication



電極付きインダクタコア
Inductor Cores with Electrodes

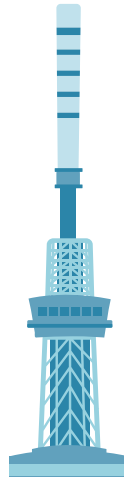

お客様のご要求に沿った設計提案

Design Proposals to Meet Customers' Requirements

京セラが長年培ったセラミック製造、及びメタライズ技術のノウハウをベースに、お客様のご要求に対して最適な形状提案を致します。

Kyocera proposes optimum shapes of fine ceramic components to meet customers' requirements based on the ceramic manufacturing and metallization technologies that Kyocera has cultivated over many years.

セラミック製造技術

Manufacturing Technologies of Ceramic Components



創業以来一貫して自社生産で培ったノウハウにより、高品質なファインセラミック部品を提供します。

Kyocera provides high-quality fine ceramic components by utilizing the expertise we have accumulated through consistent in-house manufacturing since our establishment.

メタライズ技術

Metallization Technologies



長年培ったメタライズ技術を用いて、お客様のご使用環境に最適な手法で製造を行います。

Kyocera manufactures components that are best suited to the customer's usage environment using the metallization technologies we have developed over many years.

シミュレーション技術

Simulation Technologies



セラミック/メタライズ共に自社生産で、双方の条件を考慮した正確なシミュレーションを実現します。

In-house manufacturing of both fine ceramics and metallized components enables high-precision simulation that takes the conditions of both into consideration.

商品開発力

Product Development Capability



一貫生産ラインにより、課題に対して様々な切り口からアプローチが可能で新しい製造手法を検討します。

Taking advantage of our integrated production line, Kyocera will investigate a novel manufacturing method that enables different approaches from various points of view.



目次

1. Were you aware of the vacuum components?	6
~真空部品のこと、ご存知でしょうか?~	
2. Ceramic to Metal Assemblies	8
~長年培った京セラのメタライズ技術~	
3. Ordering Process	9
~製品の選定について~	
4. For Product Selection	10
~製品選定ガイド~	
丸形多ピン端子 Circular Multi-Pin Feedthroughs	12
Multi-Pin Connectors (Bayonet Lock Series)	
Multi-Pin Connectors (MS Series)	
同軸端子 Coaxial Connectors	18
BNC Type	
SHV Type	
MHV Type	
N Type	
SMA Type	
LM Type	
Feedthroughs	27
Isolators	34
Sapphire Windows	36
Introducing New Technology	38
5. Topics	46
6. New Subsidiary Companies of the Kyocera Group	47
7. Custom-designed Ceramic Chambers	48
8. Technical Information	56
セラミックスの特性表 Characteristics of Ceramics	
形状と加工精度 Precision Shaping and Matching	
Material Comparison Chart	
接合金属の特性表 (代表例) Characteristics of Metals (Example)	
メタライズ技術 各種素材と加工 Metallization Technologies and Materials	
セラミックスと金属の基本的な接合構造 Basic Design of Ceramic-to-Metal Bonding	

Were you aware of the vacuum components?

真空部品のこと、ご存知でしょうか？

京セラの超高真空用メタライズ部品は、真空・液体・ガス環境など、大気中とは異なる環境で製造や実験を行うために使用される密閉容器（チャンバー）に使用されています。

一般的に、導通部と絶縁部を気密封止した構造となっており、京セラでは絶縁部にファインセラミックスを使用しております。この真空部品は、溶接によってフランジへ取り付けられ、Oリングやガスケットなどを使用して気密性を確保し、チャンバーへ取り付けられます。

Kyocera's ultra-high vacuum metallized components are utilized in sealed containers (chambers) for manufacturing and scientific experimentation in different environments, such as vacuum, liquid, and gas environments.

These components generally have a structure that is hermetically sealed between the conductive portion and the insulating portion. Kyocera uses fine ceramics for the insulating portion. The vacuum component is welded to the flange and installed in a chamber using an O ring and a gasket to secure hermeticity.



種類	概要
気密端子 Vacuum Feedthroughs	<p>ハーメチックシール、フィードスルー、電流導入端子などとも呼ばれ、密閉容器において信号や電流・電圧の出し入れを行う目的で容器に取り付けられます。</p> <p>Also called hermetic seals, feedthroughs, or vacuum current feedthroughs. Attached to sealed containers for taking in and putting out signals or current/voltage.</p>
絶縁部品 Electrical Insulator Parts	<p>配管の接続部の絶縁などを目的に使用されます。</p> <p>Used for electrical insulation of piping connections</p>
サファイア窓 Sapphire Windows	<p>チャンバー内部の様子を観察するための単結晶サファイアを利用した覗き窓です。</p> <p>Optical windows featuring single-crystal sapphire to observe the inside of the chamber.</p>

■一般的な気密端子の部品構成イメージ

Image of component constitution for conventional vacuum feedthrough

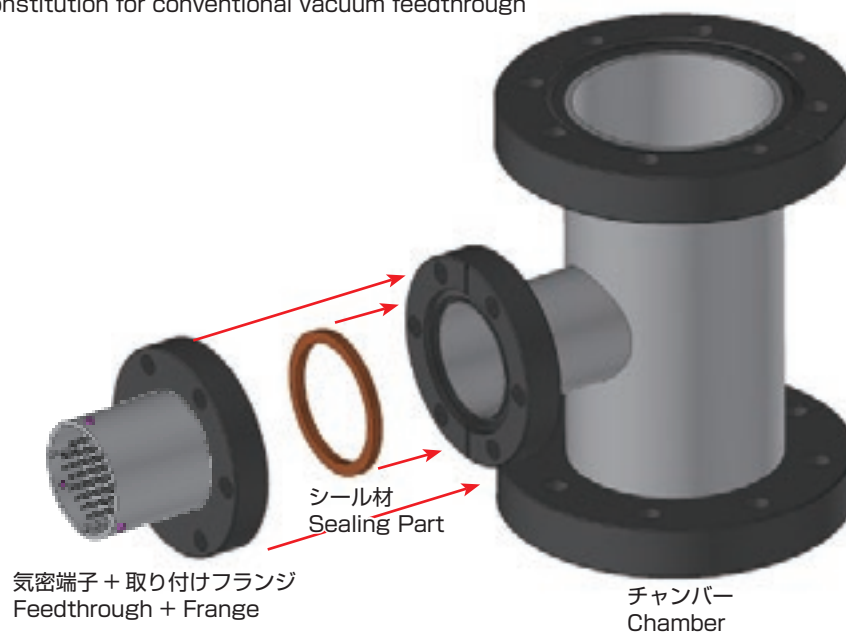

非金属（セラミックス）と金属の接合方法

Ceramic-to-Metal Bonding Technology

京セラでは、超高真空用部品を製造する際、セラミック部材と金属部材をメタライズ+ロウ付けで接合しています。では、なぜロウ付け接合なのでしょう。

一般的にセラミックスと金属を接合する場合、樹脂による接合、ガラスによる接合、そしてロウ付けによる接合の大きく3種類に分けられます。樹脂接合では、樹脂からアウトガスが発生し真空度が上がらなくなるため、高い真空環境下では使用ができません。ガラス接合では、アウトガスの発生は抑制できますが、高真空下では接合強度が不足してしまい、気密性が確保できません。これに対し、メタライズ+ロウ付けによる接合は、超高真空という過酷な環境でも高い気密性と接合強度を示します。

京セラの超高真空用部品は、長年培ったファインセラミックスの製造技術と、メタライズ技術を融合させ、厳格な基準の下で検査を行い、宇宙開発など特に信頼性が重要な分野でも採用されています。

Kyocera utilizes metallization and brazing for bonding ceramic and metallic members to manufacture ultra-high vacuum components. What are the advantages of brazing?

Generally, ceramic-to-metal bonding technology is divided into the following types: bonding with resin, bonding with glass, and bonding with brazing. Components using resin bonding cannot be used in ultra-high vacuum environments because the vacuum will not increase due to outgas from the resin. Glass bonding cannot maintain hermeticity due to insufficient bonding strength in ultra-high vacuum environments, although it can prevent outgas generation. In contrast, bonding by metallization and brazing enables high hermeticity and bonding strength, even in the harsh environment of an ultra-high vacuum.

By integrating the fine ceramic manufacturing and metallization technologies that have been cultivated for many years, Kyocera's ultra-high vacuum components are produced and inspected in accordance with strict standards. Applications are expanding into areas requiring precise reliability, such as space development.

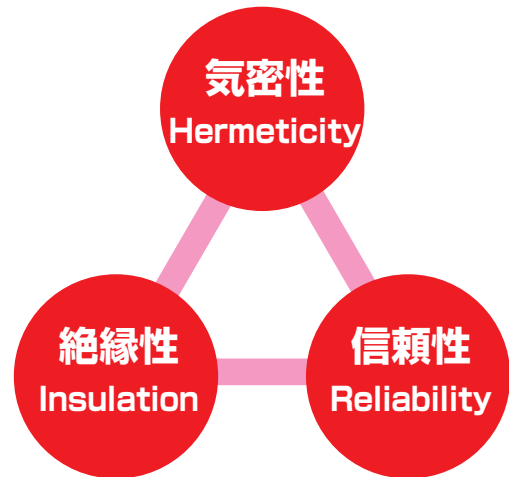

■ 接合方法による適用範囲（概念図）

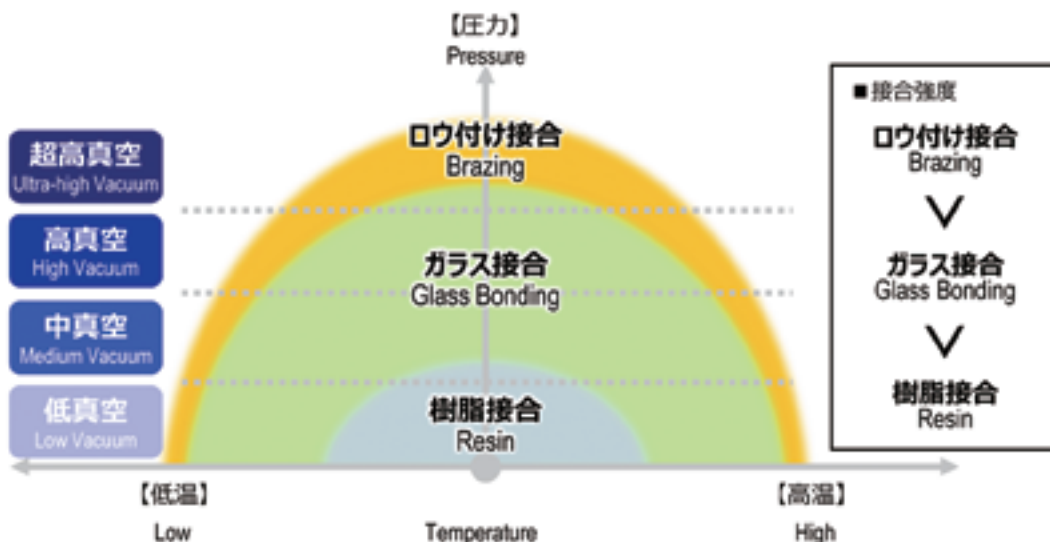

Ceramic to Metal Assemblies

長年培った京セラのメタライズ技術

強度と気密性を併せ持つメタライズ + ロウ付け接合

Strength and Hermeticity Achieved by Metallization and Brazing Bonding Technology

セラミック部品と金属部品を強固に、そして高气密に接合するためには、ロウ付けで接合することが必要です。しかし、一般にセラミックスと金属は接合性が悪く、直接接合しても強度が低く使用できません。そこで、セラミックス表面に金属層を形成し(メタライズ)、それを下地にしてロウ付け接合を行うことで、強固で高い気密性を持ったセラミックスと金属の接合を実現しています。

Bonding with brazing is essential for achieving ceramic-to-metal bonding with high strength and high hermeticity. However, the direct bonding of ceramics with metal generally results in poor characteristics leading to an inability to use the resulting products due to the weak strength. We therefore utilize metallization and brazing bonding technology, which first creates a metal layer on the ceramic surface (metallization) and then brazes the metal on the metallic surface to achieve ceramic-to-metal bonding with high strength and hermeticity.

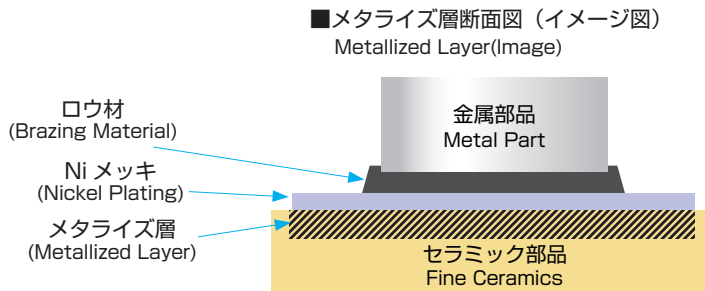

■メタライズ部品の製造工程 Metallization Process

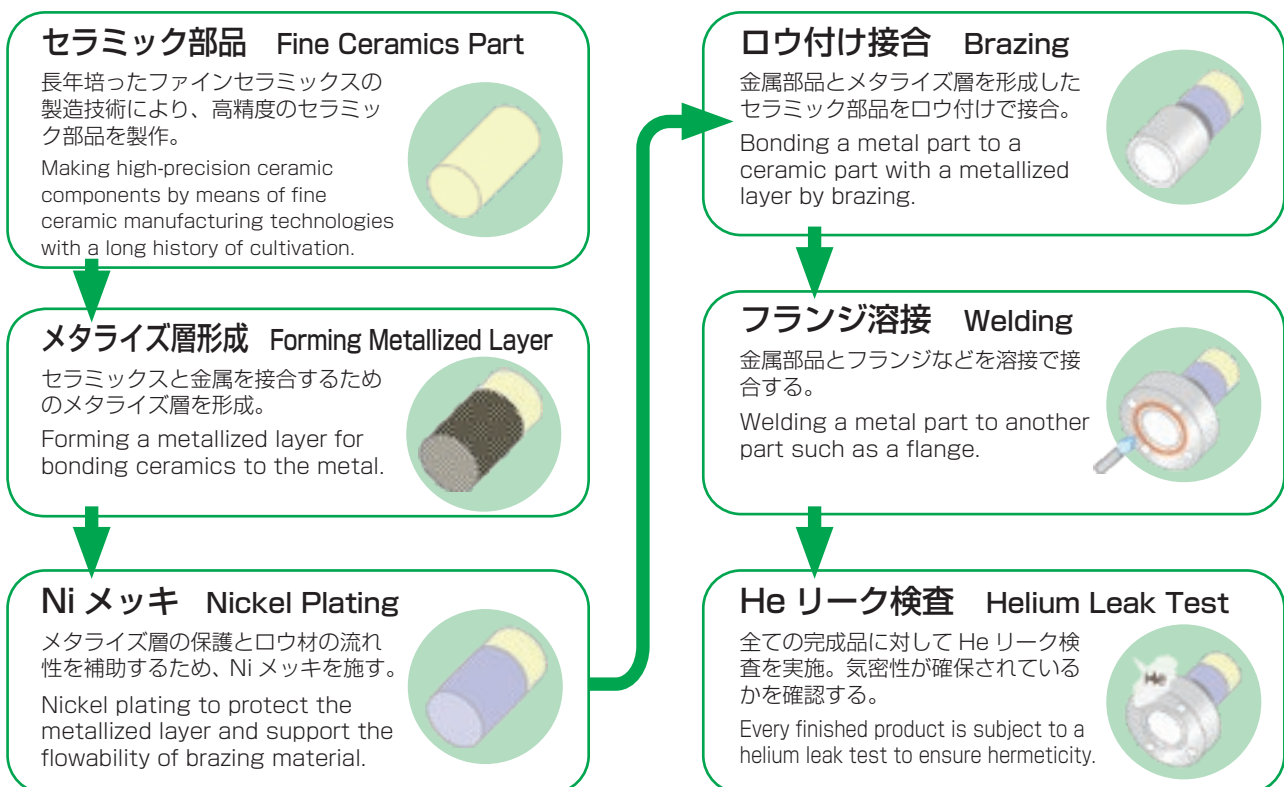

Ordering Process

製品の選定について

京セラでは気密端子のほか、金属フランジの取り付け、特殊形状の端子など、お客様のご要望に応じたカスタム対応も承っており、ご用途に対応する形状 / 材質選びのお手伝いをいたします。

In addition to the vacuum feedthrough of standard configuration, Kyocera can provide custom-made products including feedthroughs with a metal flange attached or those with a specific configuration. We will help customers to select the shapes/materials that meet their requirements.

	カタログ掲載品から選ぶ Choose from Kyocera's standard products	カスタム製作のご用命 Order customized products
Step.1 お問合せ Inquiries	<p>各種端子部品の他、絶縁継手やサファイア窓など、取り揃えています。</p> <p>Kyocera offers a variety of standard shape products including isolator flanges and sapphire windows as well as various feedthrough components.</p> <p>製品のパーツナンバーをご連絡下さい。</p> <p>Please inform us of the "Part Number" of the product.</p>	<p>ご要望の製品の詳細をご連絡下さい。</p> <p>Please inform us of the details of the required product.</p> <ul style="list-style-type: none"> - 図面 (形状がイメージできるもの) Drawing - 使用条件 Operating Conditions / 用途 Application ※差し支えない範囲で詳細をご連絡下さい Please share with us any applicable details. - 数量 Quantity - 納期 Required Delivery Date - その他ご要望やお困りの点 Other Requests or Issues
Step.2 ご提案 Proposal	<p>ご要望に応じて詳細図面をお送りいたします。</p> <p>We will send you the drawings upon request.</p>	<p>ご要望に対して可能な限り検討案を準備し、担当営業よりご一報します。</p> <p>We will provide you with our proposal for a product that meets your requirements.</p>
Step.3 ご注文 Order	<p>合意を致しました仕様に基づき、製造を開始致します。</p> <p>Production will begin according to the agreed-upon specifications and terms.</p>	
Step.4 製造 Production	<p>長年培った経験と製造技術により、ご要求に沿った製品を製造致します</p> <p>We meet your requests with our high-level expertise, wide-ranging technical capabilities and dependable production capacity</p>	
Step.5 納品 Delivery		

■ 弊社からの供給内容 Services Provided by Kyocera

	気密部品 Feedthroughs	フランジ Flange	シール材 Sealing Part	チャンバー Chambers
カタログ掲載品 Catalog Spec	弊社 Kyocera	手配 / 取り付けはお客様にてご対応 Arrangement/installation are addressed by customers.		
カタログ掲載品 + フランジ Catalog Spec + Flange	弊社 Kyocera	※フランジの形状をお知らせ下さい Please inform us of the flange shape.	手配 / 取り付けはお客様にてご対応 Arrangement/installation are addressed by customers.	
カスタム製作のご用命 (Customized Products)	ご要望に応じて端子のみ⇄チャンバー含む製作まで承ります We will accommodate customers' requirements, ranging from only providing the required feedthrough to manufacturing the entire chamber.			

For Product Selection

製品選定ガイド

■気密端子 Vacuum Feedthroughs

気密端子は、ハーメチックシールなどとも呼ばれ、主にチャンバー内外の信号や電流の導入口として使用されています。京セラでは多ピン端子の他、同軸端子や電流導入端子を取り扱っており、ご要望に応じてフランジなどの接合も行います。

Vacuum feedthroughs, also called hermetic seals, feedthroughs, or vacuum current feedthroughs, are attached to chambers mainly for taking in and putting out signals or current. Kyocera can provide standard products including feedthroughs, coaxial feedthroughs and multi-pin feedthroughs, and can accommodate customers' requirements such as flange bonding.

多ピン端子
Multi-Pin Feedthroughs

主に複数信号用
Mainly for multiple signals



→ P.12

同軸端子
Coaxial Connectors

主に高周波用
Mainly for high frequency



→ P.18

電流導入端子
Feedthroughs

主に大電流用
Mainly for high Current



→ P.27

■絶縁継手 Isolator Flanges

真空用の規格フランジに合わせた絶縁フランジです。標準寸法の他、ご希望の電圧、用途に合わせたものが製造可能です。

Isolator flanges for vacuum application. Standard sizes and custom-made flanges for voltage/usage requirements are available.



→ P.34

■サファイア窓 Sapphire Windows



単結晶サファイアを使った覗き窓です。真空用の規格フランジに合わせたサイズのほか、耐圧用の窓の製作も行います。光学用の計測窓には、無反射コーティングを行うこともできます。

Single crystal sapphire is used. In addition to sizes for standard vacuum flanges, pressure-resistant windows are available. Antireflection coating is optional for the optical measurement window.



→ P.36

■ フランジの選定 (オプション) Flange selection (optional)

		フランジの取り付け方法 Methods of attaching flanges	
		クランプ Clamping	ボルト締め Bolting
シール方法 Sealing method	Oリング O-ring	KF/NW 	VF/VG 
	金属ガスケット Metal gasket		CF/ICF 

■ 製品設計時の条件 Conditions for Product Design

- 電圧 Voltage :
定格電圧ではなく、耐電圧 (試験電圧) を記載
Withstand voltage (test voltage) is described instead of rated voltage.
- 雰囲気 Atmosphere :
大気側 : 常温・常湿・1気圧の清浄な屋内
Outside, atmosphere: clean indoors, at normal temperature and humidity, 1 atm
真空側 : 高真空下 (1×10^{-1} Pa 以下)
Inside, vacuum: under high vacuum (1×10^{-1} Pa or less)
- 温度 Temperature :
低温温度 (Minimum temp.) : -196°C
高温温度 (Maximum temp.) : 450°C
* 弊社での基礎評価、判定基準に基づいた参考値です。
製品の形状や使用状況により異なる場合があります。
Note that these numbers are meant as reference only and are based on our basic evaluation and set criteria. The numbers may vary depending on the product's shape and usage.

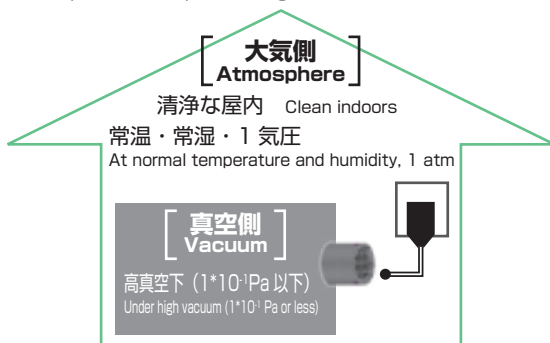

■ ご使用上の注意点 Precautions for Use

- 衝撃や無理な力をかけないでください。
Do not apply excessive force or impact.
- 大きな熱衝撃が加わると破損することがあります。
Might be damaged if thermal shock is applied.
- 汚れた場合、薬品や水を使って洗浄しないでください。アルコール等を浸み込ませたガーゼで軽くふき取ってください。
Do not use chemicals or water to wash away dirt. Lightly wipe off dirt with gauze soaked in alcohol or similar.
- ロウ付けで加熱処理された銅材は、一般より柔らかくなります。
Heat-processed brazing copper material is softer than conventional products.
- 製品とケーブルをボルト・ナット等で結線する場合、ロウ付け部に大きな力が加わらないようにしてください。
Do not apply excessive force to the brazed part when connecting products and cables with bolts / nuts.
- 溶接時は入熱量を加減してください (セラミックス近辺が 60°C 以下が望ましい)
Adjust the heat input while welding (60°C or less in the vicinity of ceramics).
- エポキシ樹脂などでピン部をモールドしないでください。熱膨張差が大きくセラミックスやピンのシール部が割れる恐れがあります。
Do not mold pins with epoxy resin; it might cause cracks on the sealed parts of ceramics and pins due to significant differences in thermal expansion.
- 製品に電流を流すと発熱します。配線の際、温度が上がりすぎないように、ご注意ください。
Current flows in the product can generate heat. Please ensure that the temperature does not rise too much when wiring.

Circular Multi-Pin Feedthroughs

丸形多ピン端子

計測・制御用の丸形多ピンフィードスルーです。バイヨネットロック型のプラグ、MIL規格準拠のプラグ、それぞれと組み合わせが可能な製品があります。ストレートチューブ構造の他、Oリングシール可能なフランジ付きのもの、スリーブの材質をアルミニウムへの変更が可能です。

Circular multi-pin feedthroughs for measurement and control use. Compatible with Bayonet lock socket or MIL standard compliant socket. In addition to straight tube configuration, Kyocera can fabricate various shapes and types including those with flanges for O-ring-seals, with aluminum sleeves, or with K and T thermocouples.

■ Bayonet Lock Series (Burndy)



バイヨネットタイプで容易に脱着が可能な多ピン端子で、バイヨネット用のボスがあるのが特徴です。

Bayonet-type featuring multi-pin feedthroughs for easy detachment and dedicated boss for Bayonet.

■ MS Series



MIL規格準拠のプラグと組み合わせが可能な多ピン端子で、ネジ山の加工が施されています。

Multi-pin feedthroughs compatible with MIL standard compliant socket.

■ (Bayonet Lock Series) プラグの組み合わせ例

(Bayonet Lock Series) Applications in Combined Sockets

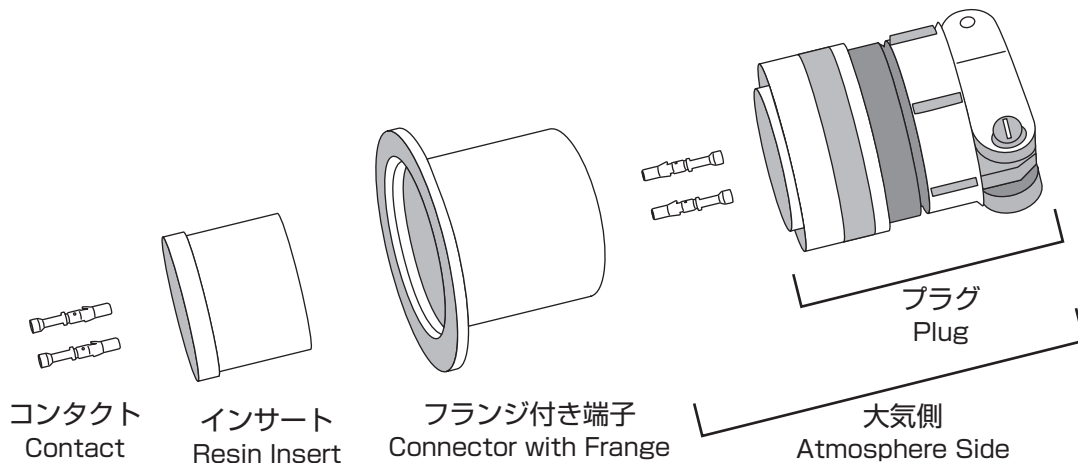

Multipin Connectors

Bayonet Lock Series

4PIN

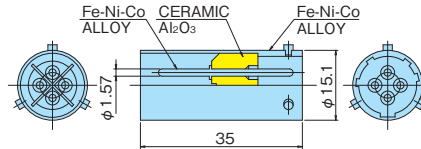

Part Number	22320
許容電流値 Current [A max] 「1本あたり」	3
耐電圧 Voltage [V max]	DC 500
気密度 Leak rate [1.3xPa · m ³ /s]	10 ⁻¹⁰
* 絶縁抵抗 Insulation [Ω min.]	10 ⁹
* 高温温度 Max. Temp. [deg.C]	450
* 低温温度 Min. Temp. [deg.C]	-196
プラグ Plug	G6A10-4SNE-JG
[Option] インサート Resin Insert	G10-4S
コンタクト Contact	RC20M-13ELD28

8PIN

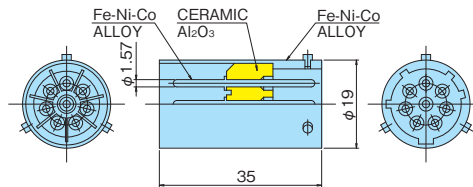

Part Number	18787
許容電流値 Current [A max] 「1本あたり」	3
耐電圧 Voltage [V max]	DC 500
気密度 Leak rate [1.3xPa · m ³ /s]	10 ⁻¹⁰
* 絶縁抵抗 Insulation [Ω min.]	10 ⁹
* 高温温度 Max. Temp. [deg.C]	450
* 低温温度 Min. Temp. [deg.C]	-196
プラグ Plug	G6A12-88SNE-JG
[Option] インサート Resin Insert	G12-88S
コンタクト Contact	RC20M-13ELD28

12PIN

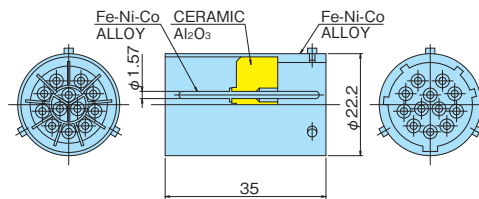

Part Number	18955
許容電流値 Current [A max] 「1本あたり」	3
耐電圧 Voltage [V max]	DC 500
気密度 Leak rate [1.3xPa · m ³ /s]	10 ⁻¹⁰
* 絶縁抵抗 Insulation [Ω min.]	10 ⁹
* 高温温度 Max. Temp. [deg.C]	450
* 低温温度 Min. Temp. [deg.C]	-196
プラグ Plug	G6A14-92SNE-JG
[Option] インサート Resin Insert	G14-92S
コンタクト Contact	RC20M-13ELD28

19PIN

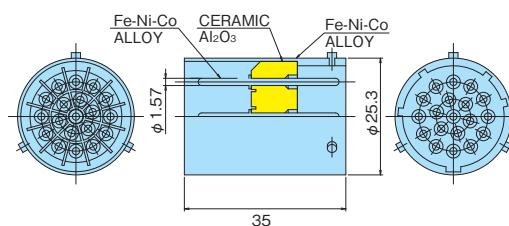

Part Number	90474
許容電流値 Current [A max] 「1本あたり」	3
耐電圧 Voltage [V max]	DC 500
気密度 Leak rate [1.3xPa · m ³ /s]	10 ⁻¹⁰
* 絶縁抵抗 Insulation [Ω min.]	10 ⁹
* 高温温度 Max. Temp. [deg.C]	450
* 低温温度 Min. Temp. [deg.C]	-196
プラグ Plug	G6A16-19SNE-JG
[Option] インサート Resin Insert	G16-19S
コンタクト Contact	RC20M-13ELD28

* 弊社での基礎評価、判定基準に基づいた参考値です。特性値は使用状況により異なる場合があります。
 Note that these numbers are meant as reference only and are based on our basic evaluation and set criteria.
 The numbers may vary depending on the product's usage.

Multipin Connectors

Bayonet Lock Series

22PIN (Aluminum Sleeve へ変更可能)

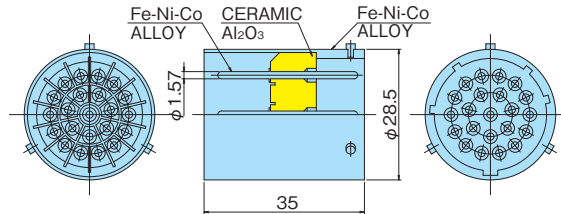

Part Number	14820
許容電流値 Current [A max] 「1本あたり」	3
耐電圧 Voltage [V max]	DC 500
気密度 Leak rate [1.3xPa · m ³ /s]	10 ⁻¹⁰
* 絶縁抵抗 Insulation [Ω min.]	10 ⁹
* 高温温度 Max. Temp. [deg.C]	450
* 低温温度 Min. Temp. [deg.C]	-196
プラグ Plug	G6A18-22SNE-JG
[Option] インサート Resin Insert	G18-22S
コンタクト Contact	RC20M-13ELD28

22PIN-Through

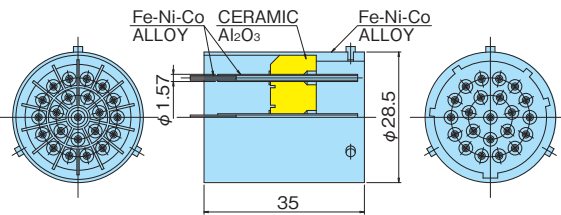

Part Number	16891
許容電流値 Current [A max] 「1本あたり」	3
耐電圧 Voltage [V max]	DC 500
気密度 Leak rate [1.3xPa · m ³ /s]	10 ⁻¹⁰
* 絶縁抵抗 Insulation [Ω min.]	10 ⁹
* 高温温度 Max. Temp. [deg.C]	450
* 低温温度 Min. Temp. [deg.C]	-196
プラグ Plug	G6A18-22SNE-JG
[Option] インサート Resin Insert	G18-22S
コンタクト Contact	RC20M-13ELD28

30PIN

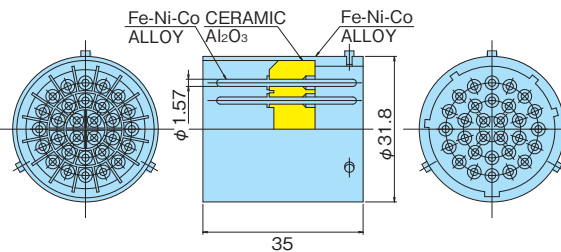

Part Number	90366
許容電流値 Current [A max] 「1本あたり」	3
耐電圧 Voltage [V max]	DC 500
気密度 Leak rate [1.3xPa · m ³ /s]	10 ⁻¹⁰
* 絶縁抵抗 Insulation [Ω min.]	10 ⁹
* 高温温度 Max. Temp. [deg.C]	450
* 低温温度 Min. Temp. [deg.C]	-196
プラグ Plug	G6A20-30SNE-JG
[Option] インサート Resin Insert	G20-30S
コンタクト Contact	RC20M-13ELD28

48PIN (Aluminum Sleeve へ変更可能)

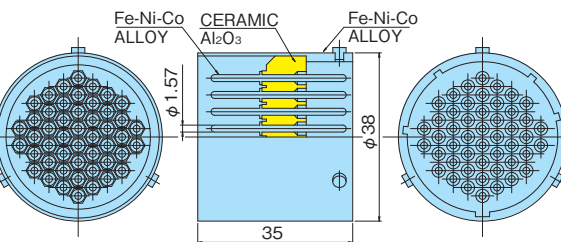

Part Number	16522
許容電流値 Current [A max] 「1本あたり」	3
耐電圧 Voltage [V max]	DC 500
気密度 Leak rate [1.3xPa · m ³ /s]	10 ⁻¹⁰
* 絶縁抵抗 Insulation [Ω min.]	10 ⁹
* 高温温度 Max. Temp. [deg.C]	450
* 低温温度 Min. Temp. [deg.C]	-196
プラグ Plug	G6A24-48SNE-JG
[Option] インサート Resin Insert	G24-48S
コンタクト Contact	RC20M-13ELD28

* 弊社での基礎評価、判定基準に基づいた参考値です。特性値は使用状況により異なる場合があります。
Note that these numbers are meant as reference only and are based on our basic evaluation and set criteria. The numbers may vary depending on the product's usage.

Multipin Connectors (Hermetic Seal Type)

Bayonet Lock Series

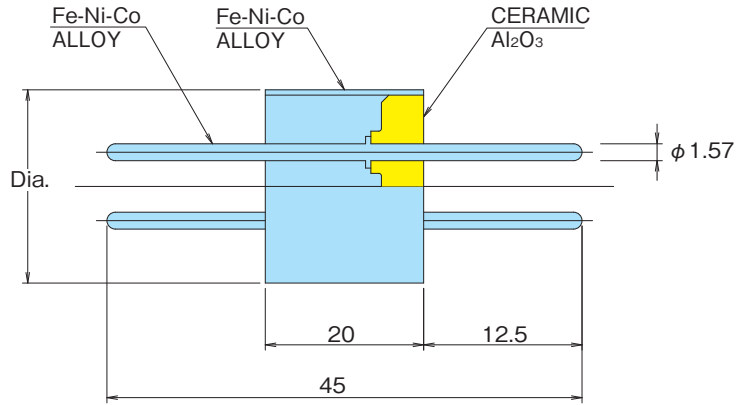
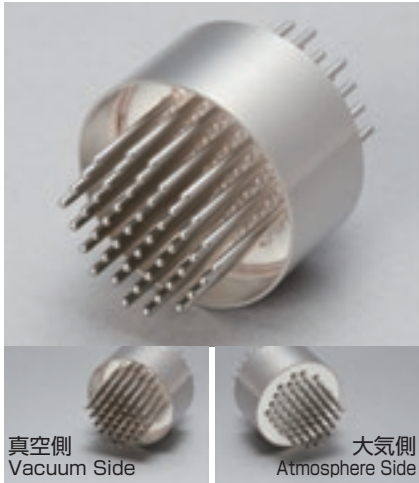

4PIN
Φ15.1mm

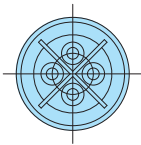

8PIN
Φ19.0mm

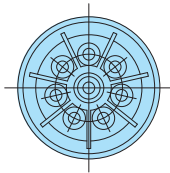

12PIN
Φ22.2mm

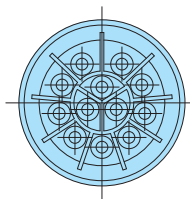

19PIN
Φ25.3mm

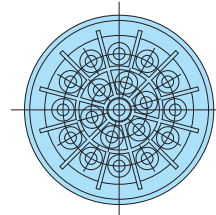

22PIN
Φ28.5mm

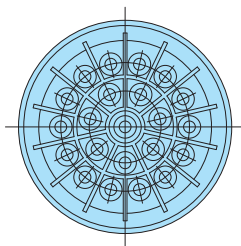

30PIN
Φ31.8mm

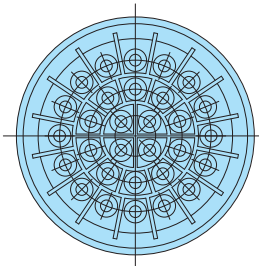

48PIN
Φ38.0mm

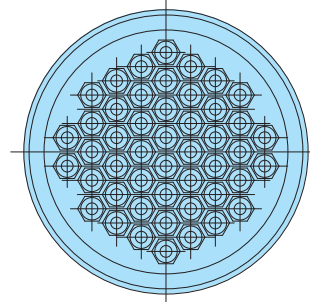

Part Number	Pin Qty	SPEC					
		許容電流値 Current [A max]	耐電圧 Voltage [V max]	* 絶縁抵抗 Insulation [Ω min.]	気密度 Leak rate [1.3xPa · m ³ /s]	* 高温温度 Max. Temp. [deg. C]	* 低温温度 Min. Temp. [deg. C]
90529	4PIN	3	DC 500	10 ⁹	10 ⁻¹⁰	450	-196
90530	8PIN						
90531	12PIN						
90532	19PIN						
90533	22PIN						
90534	30PIN						
90535	48PIN						

* 弊社での基礎評価、判定基準に基づいた参考値です。特性値は使用状況により異なる場合があります。
Note that these numbers are meant as reference only and are based on our basic evaluation and set criteria.
The numbers may vary depending on the product's usage.

Multipin Connectors

MS Series

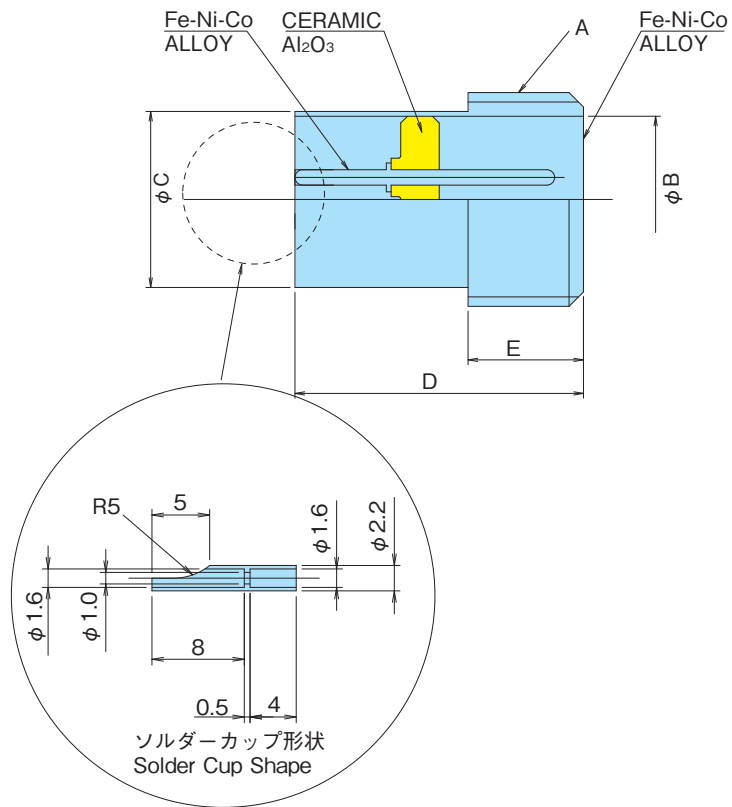
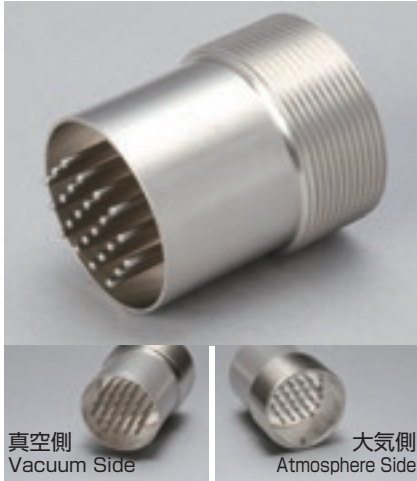

ソルダーカップ有りの対応も可。
Correspondence with Solder Cup is possible, too

Part Number	SHELL SIZE	Pin Qty	Pin Dia.	A	B	C	D	E	SPEC					
									許容電流値 Current [A max]	耐電圧 Voltage [V max]	*絶縁抵抗 Insulation [Ω min.]	気密度 Leak rate [1.3xPa·m ³ /s]	*高温温度 Max. Temp. [deg. C]	*低温温度 Min. Temp. [deg. C]
A8103	12S-3	2PIN	φ 1.6	.750-20UNEF	14.2	15.2	30	12	3	DC 500	10 ⁹	10 ⁻¹⁰	450	-196
A0647	14S-7	3PIN	φ 1.6	.875-20UNEF	17.3	18.3	30	12						
B1186	14S-2	4PIN	φ 1.6	.875-20UNEF	17.3	18.3	30	12						
93192	14S-6	6PIN	φ 1.6	.875-20UNEF	17.3	18.3	30	12						
B7760	18-11	5PIN	φ 2.4	1.125-18UNEF	23.7	25.2	49	18						
97B76	18-1	10PIN	φ 1.6	1.125-18UNEF	23.7	25.2	49	18						
A7057	20-27	14PIN	φ 1.6	1.250-18UNEF	26.8	28.3	49	18						
B7761	22-23	8PIN	φ 2.4	1.375-18UNEF	30	31.5	49	18						
91537	22-14	19PIN	φ 1.6	1.375-18UNEF	30	31.5	49	18						
91538	24-28	24PIN	φ 1.6	1.500-18UNEF	33.1	34.6	49	18						
B7762	28-6	3PIN	φ 5.7	1.750-18UNS	38.7	40.7	49	18	15					
B7763	28-12	26PIN	φ 1.6	1.750-18UNS	38.7	40.7	49	18	3	DC 500	10 ⁹	10 ⁻¹⁰	450	-196
A0618	28-21	37PIN	φ 1.6	1.750-18UNS	38.7	40.7	49	18						
93365	36-10	48PIN	φ 1.6	2.250-16UNS	50.4	52.4	49	18						

* 弊社での基礎評価、判定基準に基づいた参考値です。特性値は使用状況により異なる場合があります。
Note that these numbers are meant as reference only and are based on our basic evaluation and set criteria.
The numbers may vary depending on the product's usage.

Multipin Connectors (Hermetic Seal Type)

MS Series

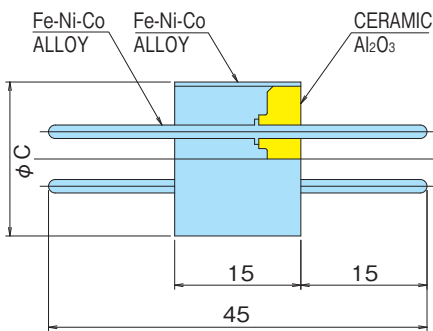
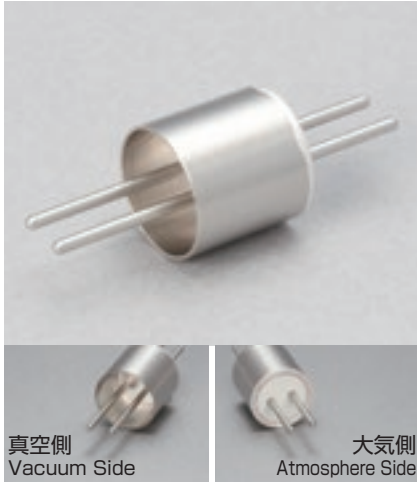

MS SERIES		WIRE No(#4 · 12 · 16) SHELL SIZE: 12S · 14S 18 · 20 · 22 · 24 · 28 · 36		PIN 1/0 WIRE No	SHELL SIZE NUMBERING SYMBOL
2 #16 (ピン径) φ1.6	12S-3	6 #16 (ピン径) φ1.6	14S-6	24 #16 (ピン径) φ1.6	24-28
3 #16 (ピン径) φ1.6	14S-7	8 #12 (ピン径) φ2.4	22-23	26 #16 (ピン径) φ1.6	28-12
3 #4 (ピン径) φ5.7	28-6	10 #16 (ピン径) φ1.6	18-1	37 #16 (ピン径) φ1.6	28-21
4 #16 (ピン径) φ1.6	14S-2	14 #16 (ピン径) φ1.6	20-27	48 #16 (ピン径) φ1.6	36-10
5 #12 (ピン径) φ2.4	18-11	19 #16 (ピン径) φ1.6	22-14		

Part Number	SHELL SIZE	Pin Qty	Pin Dia.	C	SPEC						
					許容電流値 Current [A max]	耐電圧 Voltage [V max]	* 絶縁抵抗 Insulation [Ω min.]	気密度 Leak rate [1.3xPa · m ³ /s]	* 高温温度 Max. Temp. [deg. C]	* 低温温度 Min. Temp. [deg. C]	
90578	12S-3	2PIN	φ 1.6	15.2	3	DC 500	10 ⁹	10 ⁻¹⁰	450	-196	
90579	14S-7	3PIN	φ 1.6	18.3							
90581	14S-2	4PIN	φ 1.6	18.3							
90583	14S-6	6PIN	φ 1.6	18.3							
90582	18-11	5PIN	φ 2.4	25.2							
90585	18-1	10PIN	φ 1.6	25.2							
90586	20-27	14PIN	φ 1.6	28.3							
90584	22-23	8PIN	φ 2.4	31.5							
90587	22-14	19PIN	φ 1.6	31.5							
90588	24-28	24PIN	φ 1.6	34.6							
90580	28-6	3PIN	φ 5.7	40.7							15
90589	28-12	26PIN	φ 1.6	40.7							
92466	28-21	37PIN	φ 1.6	40.7	3						
90591	36-10	48PIN	φ 1.6	47.1							

* 弊社での基礎評価、判定基準に基づいた参考値です。特性値は使用状況により異なる場合があります。
 Note that these numbers are meant as reference only and are based on our basic evaluation and set criteria.
 The numbers may vary depending on the product's usage.

Coaxial Connectors

同軸端子

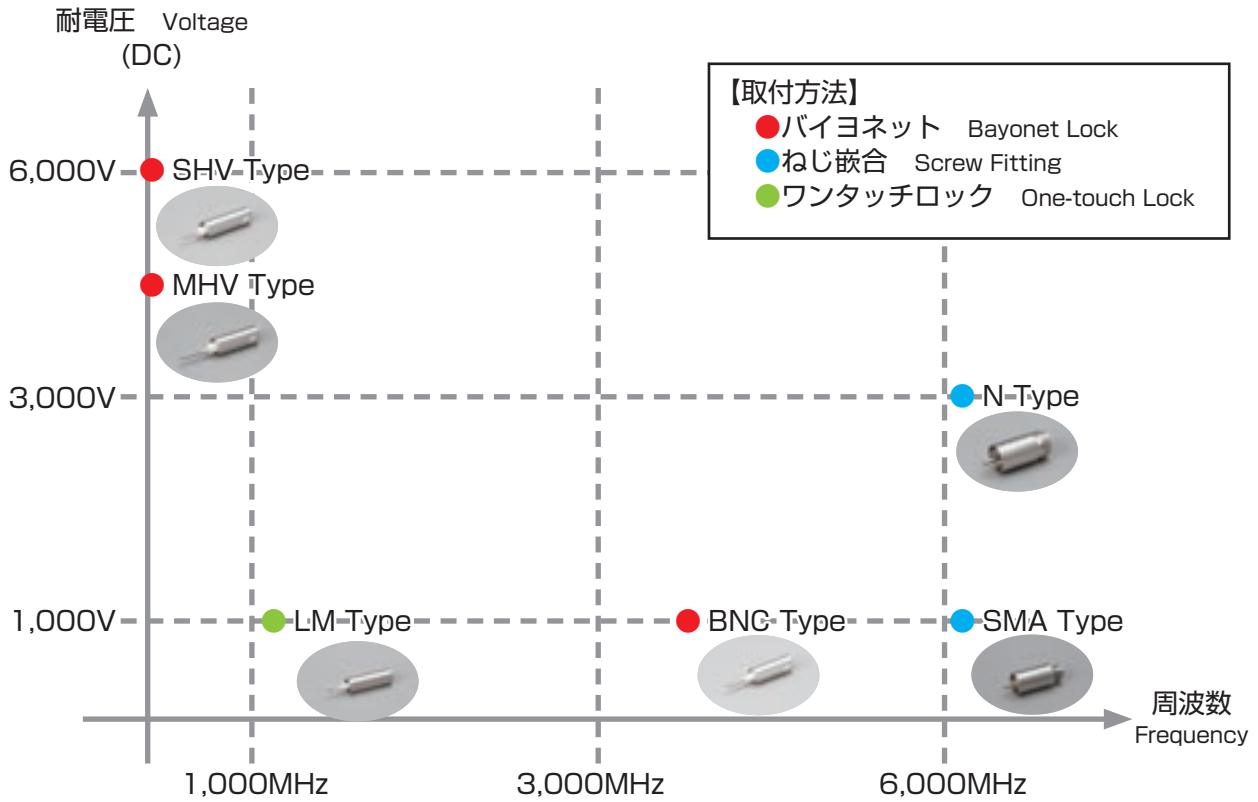

■ グランドシールド Grounded Shield

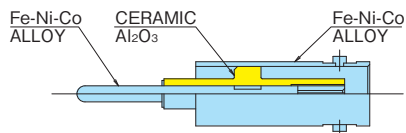

一般的な気密端子です。
Conventional vacuum feedthrough

■ フローティングシールド Floating Shield

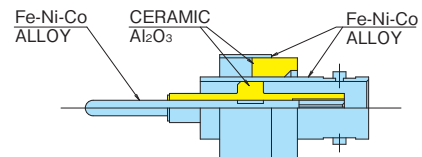

端子部分をフランジ等の取り付け部分から完全に独立させ、周囲の環境による影響（ノイズ等）を受けにくい構造の気密端子です。

It has a construction that is less susceptible to the influences of the surrounding environment (noise, etc.) due to the complete separation of the terminal part from the attachment part of the flange, etc.

Coaxial Connectors

同軸端子

製品の高周波特性 (例) *

Product RF Characteristics (Example) *

■BNC-JJ

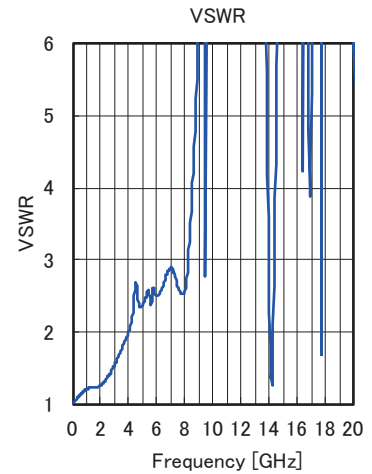
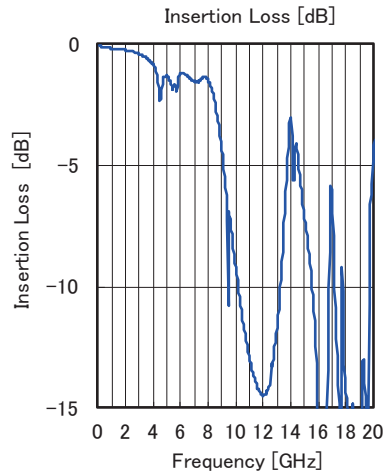
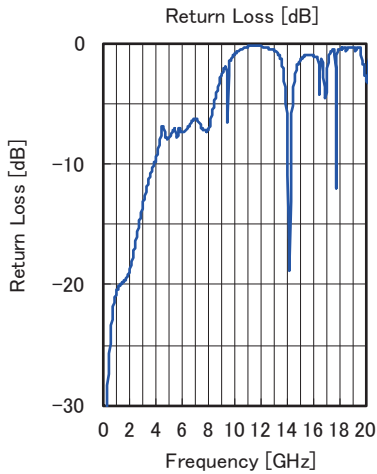

■N-JJ

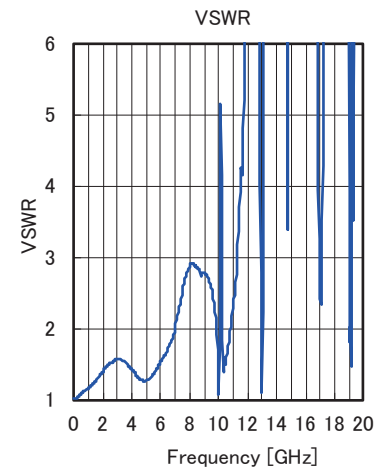
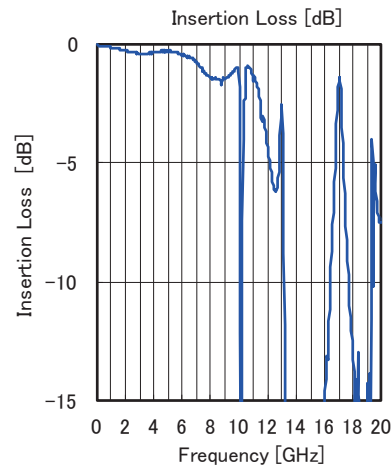
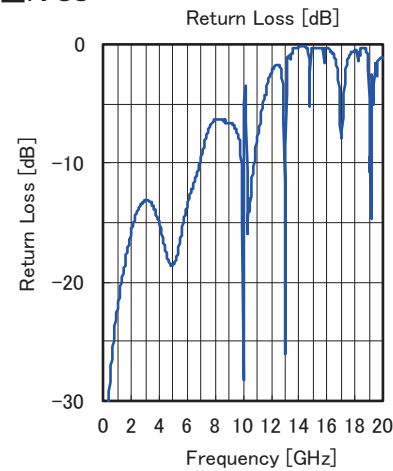

■SMA-JJ

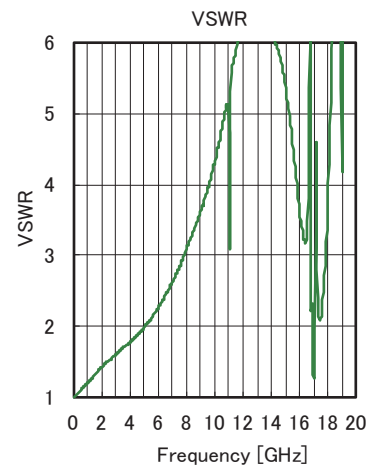
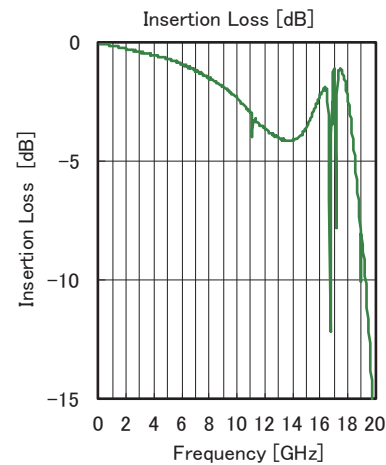
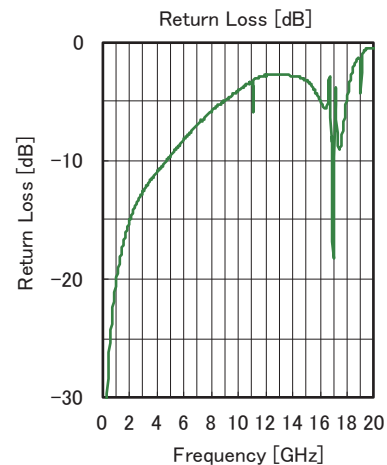

* 弊社での基礎評価、判定基準に基づいた参考値です。特性値は使用状況により異なる場合があります。
Note that these numbers are meant as reference only and are based on our basic evaluation and set criteria.
The numbers may vary depending on the product's usage.

Coaxial Connectors

同軸端子

BNC-R

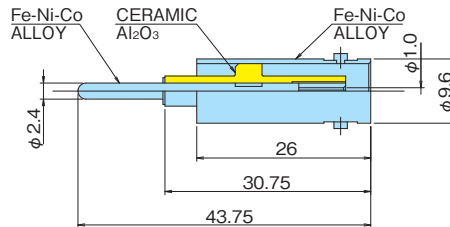

Part Number	16155
TYPE	-
許容電流値 Current [A max]	3
耐電圧 Voltage [V max]	DC 1,000
抵抗 Impedance [Ω]	50
気密度 Leak rate [1.3xPa · m ³ /s]	10 ⁻¹⁰
* 絶縁抵抗 Insulation [Ω min.]	10 ⁹
* 高温温度 Max. Temp. [deg. C]	450
* 低温温度 Min. Temp. [deg. C]	-196
[Option] プラグ Plug	BNC-P-3
コンタクト Contact	-

BNC-R-F

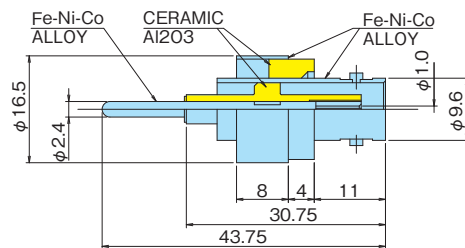

Part Number	14516
TYPE	Floating
許容電流値 Current [A max]	3
耐電圧 Voltage [V max]	DC 1,000
抵抗 Impedance [Ω]	50
気密度 Leak rate [1.3xPa · m ³ /s]	10 ⁻¹⁰
* 絶縁抵抗 Insulation [Ω min.]	10 ⁹
* 高温温度 Max. Temp. [deg. C]	450
* 低温温度 Min. Temp. [deg. C]	-196
[Option] プラグ Plug	BNC-P-3
コンタクト Contact	-

BNC-JJ

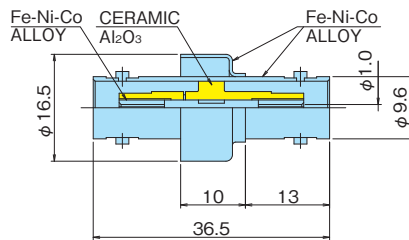

Part Number	15760
TYPE	-
許容電流値 Current [A max]	3
耐電圧 Voltage [V max]	DC 1,000
抵抗 Impedance [Ω]	50
気密度 Leak rate [1.3xPa · m ³ /s]	10 ⁻¹⁰
* 絶縁抵抗 Insulation [Ω min.]	10 ⁹
* 高温温度 Max. Temp. [deg. C]	450
* 低温温度 Min. Temp. [deg. C]	-196
[Option] プラグ Plug	BNC-P-3
コンタクト Contact	-

BNC-JJ-F

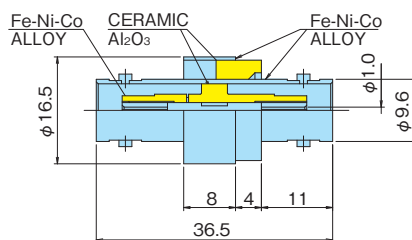

Part Number	15759
TYPE	Floating
許容電流値 Current [A max]	3
耐電圧 Voltage [V max]	DC 1,000
抵抗 Impedance [Ω]	50
気密度 Leak rate [1.3xPa · m ³ /s]	10 ⁻¹⁰
* 絶縁抵抗 Insulation [Ω min.]	10 ⁹
* 高温温度 Max. Temp. [deg. C]	450
* 低温温度 Min. Temp. [deg. C]	-196
[Option] プラグ Plug	BNC-P-3
コンタクト Contact	-

* 弊社での基礎評価、判定基準に基づいた参考値です。特性値は使用状況により異なる場合があります。
 Note that these numbers are meant as reference only and are based on our basic evaluation and set criteria.
 The numbers may vary depending on the product's usage.

Coaxial Connectors

同軸端子

BNC-R-M2 SCREW

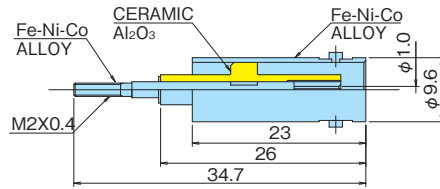

Part Number	17290
TYPE	-
許容電流値 Current [A max]	3
耐電圧 Voltage [V max]	DC 1,000
抵抗 Impedance [Ω]	50
気密度 Leak rate [1.3xPa · m ³ /s]	10 ⁻¹⁰
* 絶縁抵抗 Insulation [Ω min.]	10 ⁹
* 高温温度 Max. Temp. [deg. C]	450
* 低温温度 Min. Temp. [deg. C]	-196
[Option] プラグ Plug	BNC-P-3
コンタクト Contact	-

BNC-R-F-M2 SCREW

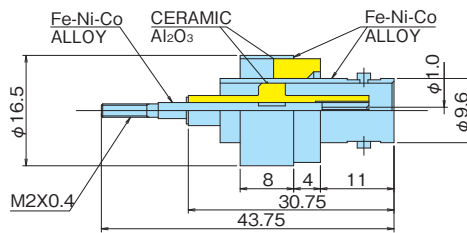

Part Number	90166
TYPE	Floating
許容電流値 Current [A max]	3
耐電圧 Voltage [V max]	DC 1,000
抵抗 Impedance [Ω]	50
気密度 Leak rate [1.3xPa · m ³ /s]	10 ⁻¹⁰
* 絶縁抵抗 Insulation [Ω min.]	10 ⁹
* 高温温度 Max. Temp. [deg. C]	450
* 低温温度 Min. Temp. [deg. C]	-196
[Option] プラグ Plug	BNC-P-3
コンタクト Contact	-

5KV-BNC-R

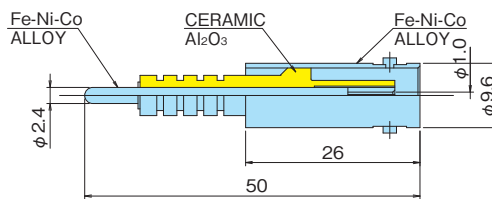

Part Number	94331
TYPE	-
許容電流値 Current [A max]	3
耐電圧 Voltage [V max]	DC 5,000
抵抗 Impedance [Ω]	50
気密度 Leak rate [1.3xPa · m ³ /s]	10 ⁻¹⁰
* 絶縁抵抗 Insulation [Ω min.]	10 ⁹
* 高温温度 Max. Temp. [deg. C]	450
* 低温温度 Min. Temp. [deg. C]	-196
[Option] プラグ Plug	11H4-50-4-4
コンタクト Contact	-

15KV-F-Coaxial

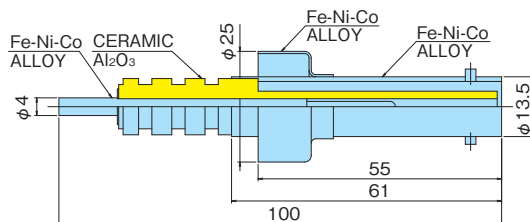

Part Number	A5051
TYPE	-
許容電流値 Current [A max]	10
耐電圧 Voltage [V max]	DC 15,000
抵抗 Impedance [Ω]	50
気密度 Leak rate [1.3xPa · m ³ /s]	10 ⁻¹⁰
* 絶縁抵抗 Insulation [Ω min.]	10 ⁹
* 高温温度 Max. Temp. [deg. C]	450
* 低温温度 Min. Temp. [deg. C]	-196
[Option] プラグ Plug	-
コンタクト Contact	-

* 弊社での基礎評価、判定基準に基づいた参考値です。特性値は使用状況により異なる場合があります。
 Note that these numbers are meant as reference only and are based on our basic evaluation and set criteria.
 The numbers may vary depending on the product's usage.

Coaxial Connectors

同軸端子

SHV-R

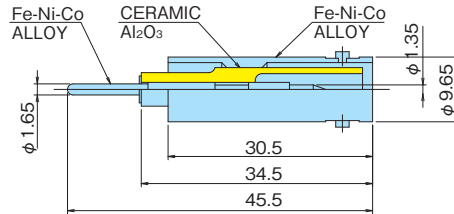

Part Number	17847
TYPE	-
許容電流値 Current [A max]	3
耐電圧 Voltage [V max]	DC 6,000
抵抗 Impedance [Ω]	50
気密度 Leak rate [1.3xPa · m ³ /s]	10 ⁻¹⁰
* 絶縁抵抗 Insulation [Ω min.]	10 ⁹
* 高温温度 Max. Temp. [deg. C]	450
* 低温温度 Min. Temp. [deg. C]	-196
[Option] プラグ Plug	11SHV50-4-1C
コンタクト Contact	RC20M-13ELD28

SHV-R-F

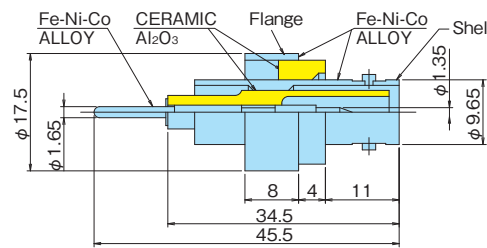

Part Number	90162
TYPE	Floating
許容電流値 Current [A max]	3
耐電圧 Voltage [V max]	DC 6,000 (Shell-to-Flange D.C 1,000)
抵抗 Impedance [Ω]	50
気密度 Leak rate [1.3xPa · m ³ /s]	10 ⁻¹⁰
* 絶縁抵抗 Insulation [Ω min.]	10 ⁹
* 高温温度 Max. Temp. [deg. C]	450
* 低温温度 Min. Temp. [deg. C]	-196
[Option] プラグ Plug	11SHV50-4-1C
コンタクト Contact	RC20M-13ELD28

SHV-JJ

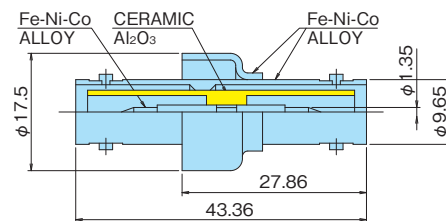

Part Number	90165
TYPE	-
許容電流値 Current [A max]	3
耐電圧 Voltage [V max]	DC 6,000
抵抗 Impedance [Ω]	50
気密度 Leak rate [1.3xPa · m ³ /s]	10 ⁻¹⁰
* 絶縁抵抗 Insulation [Ω min.]	10 ⁹
* 高温温度 Max. Temp. [deg. C]	450
* 低温温度 Min. Temp. [deg. C]	-196
[Option] プラグ Plug	11SHV50-4-1C
コンタクト Contact	-

SHV-JJ-F

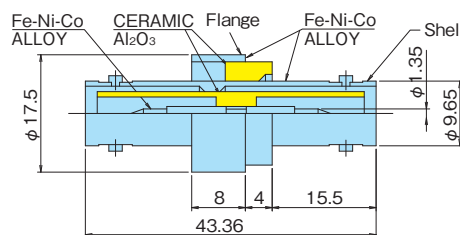

Part Number	85205
TYPE	Floating
許容電流値 Current [A max]	3
耐電圧 Voltage [V max]	DC 6,000 (Shell-to-Flange D.C 1,000)
抵抗 Impedance [Ω]	50
気密度 Leak rate [1.3xPa · m ³ /s]	10 ⁻¹⁰
* 絶縁抵抗 Insulation [Ω min.]	10 ⁹
* 高温温度 Max. Temp. [deg. C]	450
* 低温温度 Min. Temp. [deg. C]	-196
[Option] プラグ Plug	11SHV50-4-1C
コンタクト Contact	-

* 弊社での基礎評価、判定基準に基づいた参考値です。特性値は使用状況により異なる場合があります。
 Note that these numbers are meant as reference only and are based on our basic evaluation and set criteria.
 The numbers may vary depending on the product's usage.

Coaxial Connectors

同軸端子

MHV-R

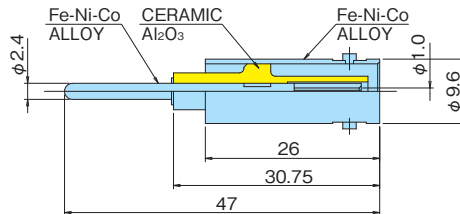

Part Number	86537
TYPE	-
許容電流値 Current [A max]	3
耐電圧 Voltage [V max]	DC 5,000
抵抗 Impedance [Ω]	50
気密度 Leak rate [1.3xPa · m ³ /s]	10 ⁻¹⁰
* 絶縁抵抗 Insulation [Ω min.]	10 ⁹
* 高温温度 Max. Temp. [deg. C]	450
* 低温温度 Min. Temp. [deg. C]	-196
[Option] プラグ Plug	11H4-50-4-4
コンタクト Contact	-

MHV-R-F

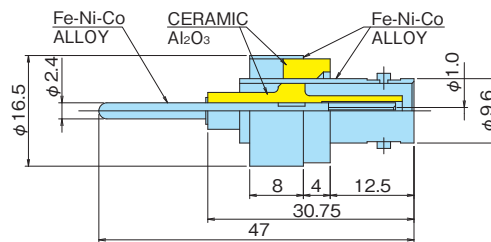

Part Number	90179
TYPE	Floating
許容電流値 Current [A max]	3
耐電圧 Voltage [V max]	DC 5,000
抵抗 Impedance [Ω]	50
気密度 Leak rate [1.3xPa · m ³ /s]	10 ⁻¹⁰
* 絶縁抵抗 Insulation [Ω min.]	10 ⁹
* 高温温度 Max. Temp. [deg. C]	450
* 低温温度 Min. Temp. [deg. C]	-196
[Option] プラグ Plug	11H4-50-4-4
コンタクト Contact	-

MHV-JJ

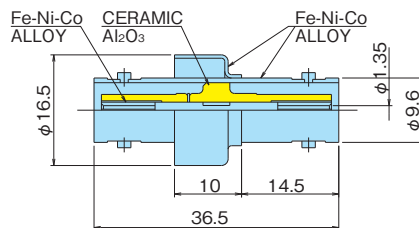

Part Number	20414
TYPE	-
許容電流値 Current [A max]	3
耐電圧 Voltage [V max]	DC 5,000
抵抗 Impedance [Ω]	50
気密度 Leak rate [1.3xPa · m ³ /s]	10 ⁻¹⁰
* 絶縁抵抗 Insulation [Ω min.]	10 ⁹
* 高温温度 Max. Temp. [deg. C]	450
* 低温温度 Min. Temp. [deg. C]	-196
[Option] プラグ Plug	11H4-50-4-4
コンタクト Contact	-

MHV-JJ-F

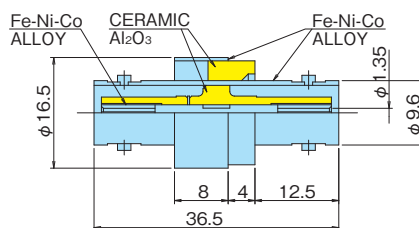

Part Number	18737
TYPE	Floating
許容電流値 Current [A max]	3
耐電圧 Voltage [V max]	DC 5,000
抵抗 Impedance [Ω]	50
気密度 Leak rate [1.3xPa · m ³ /s]	10 ⁻¹⁰
* 絶縁抵抗 Insulation [Ω min.]	10 ⁹
* 高温温度 Max. Temp. [deg. C]	450
* 低温温度 Min. Temp. [deg. C]	-196
[Option] プラグ Plug	11H4-50-4-4
コンタクト Contact	-

* 弊社での基礎評価、判定基準に基づいた参考値です。特性値は使用状況により異なる場合があります。
Note that these numbers are meant as reference only and are based on our basic evaluation and set criteria.
The numbers may vary depending on the product's usage.

Coaxial Connectors

同軸端子

N-R

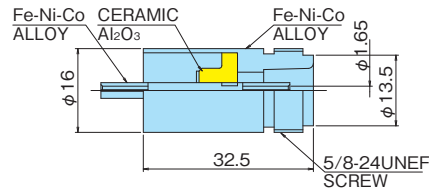

Part Number	16297
TYPE	-
許容電流値 Current [A max]	5
耐電圧 Voltage [V max]	DC 3,000
抵抗 Impedance [Ω]	50
気密度 Leak rate [1.3xPa · m ³ /s]	10 ⁻¹⁰
* 絶縁抵抗 Insulation [Ω min.]	10 ⁹
* 高温温度 Max. Temp. [deg. C]	450
* 低温温度 Min. Temp. [deg. C]	-196
[Option] プラグ Plug	N-P-58U
[Option] コンタクト Contact	RM20M-13D28

N-R-F

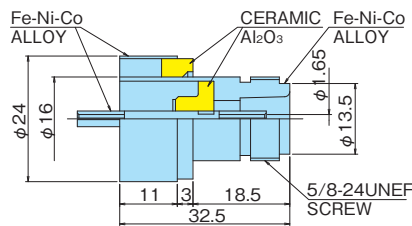
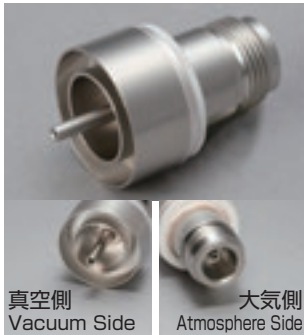

Part Number	16632
TYPE	Floating
許容電流値 Current [A max]	5
耐電圧 Voltage [V max]	DC 3,000
抵抗 Impedance [Ω]	50
気密度 Leak rate [1.3xPa · m ³ /s]	10 ⁻¹⁰
* 絶縁抵抗 Insulation [Ω min.]	10 ⁹
* 高温温度 Max. Temp. [deg. C]	450
* 低温温度 Min. Temp. [deg. C]	-196
[Option] プラグ Plug	N-P-58U
[Option] コンタクト Contact	RM20M-13D28

N-JJ

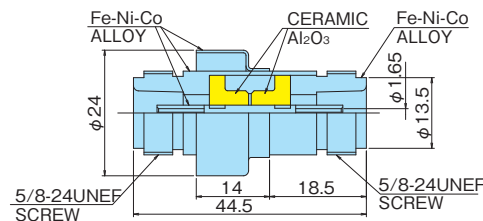

Part Number	16634
TYPE	-
許容電流値 Current [A max]	5
耐電圧 Voltage [V max]	DC 3,000
抵抗 Impedance [Ω]	50
気密度 Leak rate [1.3xPa · m ³ /s]	10 ⁻¹⁰
* 絶縁抵抗 Insulation [Ω min.]	10 ⁹
* 高温温度 Max. Temp. [deg. C]	450
* 低温温度 Min. Temp. [deg. C]	-196
[Option] プラグ Plug	N-P-58U
[Option] コンタクト Contact	-

N-JJ-F

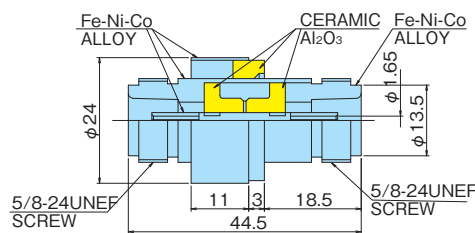

Part Number	16633
TYPE	Floating
許容電流値 Current [A max]	5
耐電圧 Voltage [V max]	DC 3,000
抵抗 Impedance [Ω]	50
気密度 Leak rate [1.3xPa · m ³ /s]	10 ⁻¹⁰
* 絶縁抵抗 Insulation [Ω min.]	10 ⁹
* 高温温度 Max. Temp. [deg. C]	450
* 低温温度 Min. Temp. [deg. C]	-196
[Option] プラグ Plug	N-P-58U
[Option] コンタクト Contact	-

* 弊社での基礎評価、判定基準に基づいた参考値です。特性値は使用状況により異なる場合があります。
 Note that these numbers are meant as reference only and are based on our basic evaluation and set criteria.
 The numbers may vary depending on the product's usage.

Coaxial Connectors

同軸端子

SMA-R

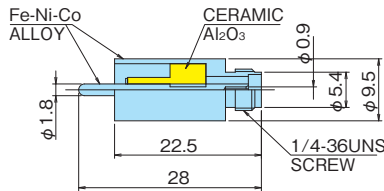

Part Number	17545
TYPE	-
許容電流値 Current [A max]	3
耐電圧 Voltage [V max]	DC 1,000
抵抗 Impedance [Ω]	50
気密度 Leak rate [1.3xPa · m ³ /s]	10 ⁻¹⁰
* 絶縁抵抗 Insulation [Ω min.]	10 ⁹
* 高温温度 Max. Temp. [deg. C]	450
* 低温温度 Min. Temp. [deg. C]	-196
[Option] プラグ Plug	11SMA-50-3-7C
[Option] コンタクト Contact	-

SMA-R-F

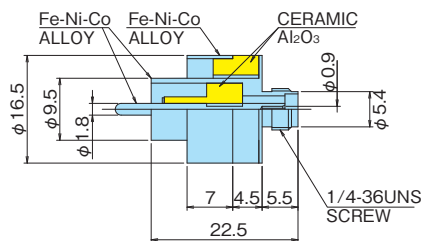

Part Number	90174
TYPE	Floating
許容電流値 Current [A max]	3
耐電圧 Voltage [V max]	DC 1,000
抵抗 Impedance [Ω]	50
気密度 Leak rate [1.3xPa · m ³ /s]	10 ⁻¹⁰
* 絶縁抵抗 Insulation [Ω min.]	10 ⁹
* 高温温度 Max. Temp. [deg. C]	450
* 低温温度 Min. Temp. [deg. C]	-196
[Option] プラグ Plug	11SMA-50-3-7C
[Option] コンタクト Contact	-

SMA-JJ

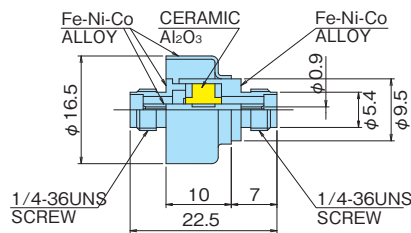

Part Number	17717
TYPE	-
許容電流値 Current [A max]	3
耐電圧 Voltage [V max]	DC 1,000
抵抗 Impedance [Ω]	50
気密度 Leak rate [1.3xPa · m ³ /s]	10 ⁻¹⁰
* 絶縁抵抗 Insulation [Ω min.]	10 ⁹
* 高温温度 Max. Temp. [deg. C]	450
* 低温温度 Min. Temp. [deg. C]	-196
[Option] プラグ Plug	11SMA-50-3-7C
[Option] コンタクト Contact	-

SMA-JJ-F

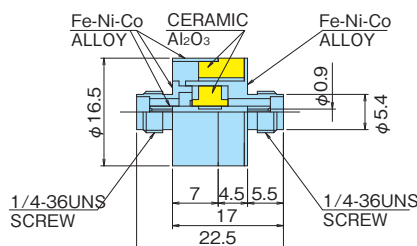
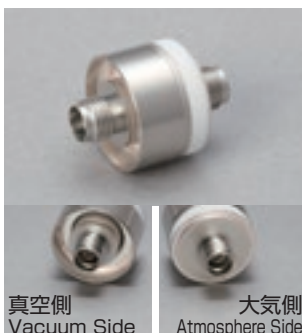

Part Number	87200
TYPE	Floating
許容電流値 Current [A max]	3
耐電圧 Voltage [V max]	DC 1,000
抵抗 Impedance [Ω]	50
気密度 Leak rate [1.3xPa · m ³ /s]	10 ⁻¹⁰
* 絶縁抵抗 Insulation [Ω min.]	10 ⁹
* 高温温度 Max. Temp. [deg. C]	450
* 低温温度 Min. Temp. [deg. C]	-196
[Option] プラグ Plug	11SMA-50-3-7C
[Option] コンタクト Contact	-

* 弊社での基礎評価、判定基準に基づいた参考値です。特性値は使用状況により異なる場合があります。
Note that these numbers are meant as reference only and are based on our basic evaluation and set criteria.
The numbers may vary depending on the product's usage.

Coaxial Connectors

同軸端子

LEMO 社の LEMO 00 シリーズに嵌合する同軸端子です。
 Following Coaxial Connectors conform with LEMO 00series connectors which produced by LEMO.

LM-00R

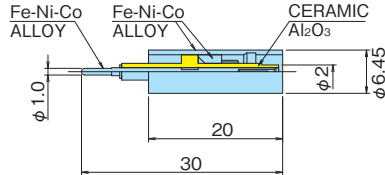

Part Number	17057
TYPE	-
許容電流値 Current [A max]	2
耐電圧 Voltage [V max]	DC 1,000
抵抗 Impedance [Ω]	50
気密度 Leak rate [1.3xPa · m ³ /s]	10 ⁻¹⁰
* 絶縁抵抗 Insulation [Ω min.]	10 ⁹
* 高温温度 Max. Temp. [deg. C]	450
* 低温温度 Min. Temp. [deg. C]	-196
[Option] プラグ Plug	FFA00 250 CTAC31
コンタクト Contact	B1-No41.0001

LM-R-F

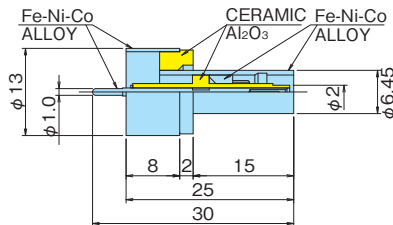
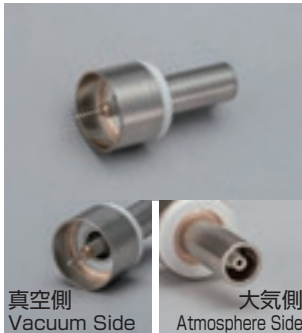

Part Number	86379
TYPE	Floating
許容電流値 Current [A max]	2
耐電圧 Voltage [V max]	DC 1,000
抵抗 Impedance [Ω]	50
気密度 Leak rate [1.3xPa · m ³ /s]	10 ⁻¹⁰
* 絶縁抵抗 Insulation [Ω min.]	10 ⁹
* 高温温度 Max. Temp. [deg. C]	450
* 低温温度 Min. Temp. [deg. C]	-196
[Option] プラグ Plug	FFA00 250 CTAC31
コンタクト Contact	B1-No41.0001

LM-JJ

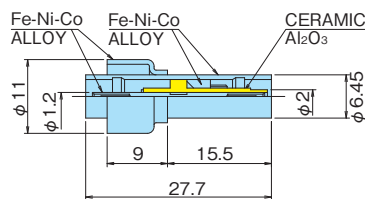

Part Number	18666
TYPE	-
許容電流値 Current [A max]	2
耐電圧 Voltage [V max]	DC 1,000
抵抗 Impedance [Ω]	50
気密度 Leak rate [1.3xPa · m ³ /s]	10 ⁻¹⁰
* 絶縁抵抗 Insulation [Ω min.]	10 ⁹
* 高温温度 Max. Temp. [deg. C]	450
* 低温温度 Min. Temp. [deg. C]	-196
[Option] プラグ Plug	FFA00 250 CTAC31
コンタクト Contact	-

LM-JJ-F

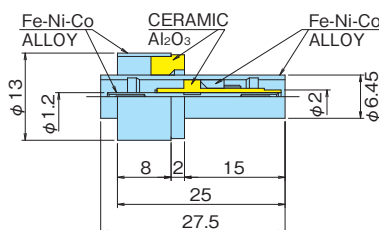

Part Number	86380
TYPE	Floating
許容電流値 Current [A max]	2
耐電圧 Voltage [V max]	DC 1,000
抵抗 Impedance [Ω]	50
気密度 Leak rate [1.3xPa · m ³ /s]	10 ⁻¹⁰
* 絶縁抵抗 Insulation [Ω min.]	10 ⁹
* 高温温度 Max. Temp. [deg. C]	450
* 低温温度 Min. Temp. [deg. C]	-196
[Option] プラグ Plug	FFA00 250 CTAC31
コンタクト Contact	-

* 弊社での基礎評価、判定基準に基づいた参考値です。特性値は使用状況により異なる場合があります。
 Note that these numbers are meant as reference only and are based on our basic evaluation and set criteria.
 The numbers may vary depending on the product's usage.

Feedthroughs

電力、ヒーター、ランプなど大きな電流を使用するのに適しています。最高使用電圧・電流容量・スリーブ材質や釉薬有無の組み合わせから選択ください。また、ご希望に沿う条件のものが無い場合には、カスタムでの製作を致しますのでお問い合わせください。

Suitable for equipment that uses high current such as power, heaters and lamps. Please choose an appropriate combination of the maximum use voltage, current capacity, sleeve material, and glaze use. Kyocera is able to provide custom-made products other than the above; please feel free to contact us.

TYPE 表記方法:
Notation for TYPE

5KV-6-KV-KV-G

① ② ③ ④ ⑤

①耐電圧 voltage	[材質の表記] Material KV=Fe-Ni-Co Cu=O.F.H.C SUS=SUS
②電極径 Electrode Dia. (mm)	
③電極材質 Electrode Material	
④スリーブ材質 Sleeve Material	
⑤釉薬 Glaze	

■耐電圧 Voltage[DC. MAX]



5KV



10KV

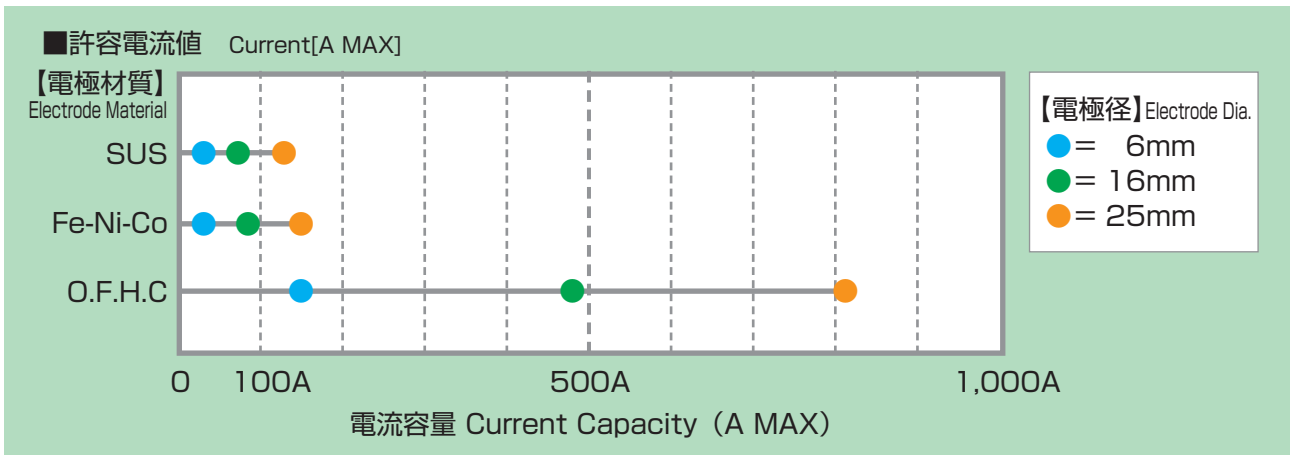

■オプションの選定 Option

- スリーブ材質: Fe-Ni-Co or SUS
Sleeve Material
- 釉薬: Glaze

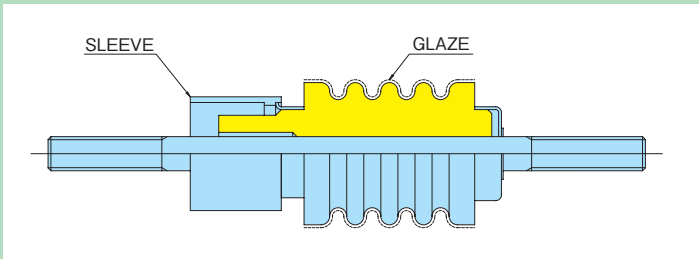

Feedthroughs

[5KV-6]

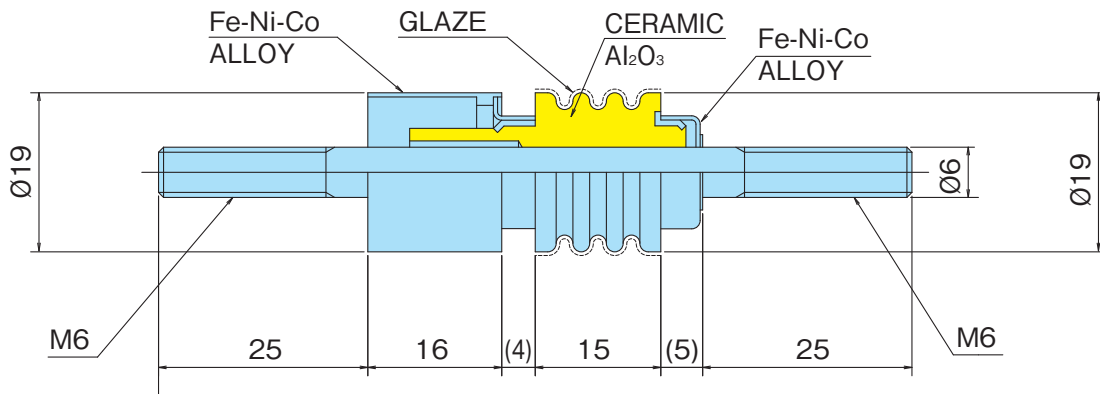

Part Number	TYPE	耐電圧 VOLTAGE [DC MAX]	許容電流値 Current [A MAX]	*絶縁抵抗 Insulation [Ω at DC500V]	気密性 Leak rate [1.3 × Pa·m ³ /s]	電極材質 Electrode	スリーブ材質 Sleeve	釉薬 Glaze
87000-1	5KV-6-SUS-SUS-G	5KV	22	10 ⁹	10 ⁻¹⁰	SUS	SUS	Glazed
87000-20	5KV-6-SUS-SUS	5KV	22	10 ⁹	10 ⁻¹⁰	SUS	SUS	—
87000-14	5KV-6-SUS-KV-G	5KV	22	10 ⁹	10 ⁻¹⁰	SUS	Fe-Ni-Co	Glazed
87000-17	5KV-6-SUS-KV	5KV	22	10 ⁹	10 ⁻¹⁰	SUS	Fe-Ni-Co	—
87000-11	5KV-6-KV-SUS-G	5KV	27	10 ⁹	10 ⁻¹⁰	Fe-Ni-Co	SUS	Glazed
87000-19	5KV-6-KV-SUS	5KV	27	10 ⁹	10 ⁻¹⁰	Fe-Ni-Co	SUS	—
87000-13	5KV-6-KV-KV-G	5KV	27	10 ⁹	10 ⁻¹⁰	Fe-Ni-Co	Fe-Ni-Co	Glazed
87000-16	5KV-6-KV-KV	5KV	27	10 ⁹	10 ⁻¹⁰	Fe-Ni-Co	Fe-Ni-Co	—
87000-60	5KV-6-Cu-SUS-G	5KV	145	10 ⁹	10 ⁻¹⁰	O.F.H.C	SUS	Glazed
87000-21	5KV-6-Cu-SUS	5KV	145	10 ⁹	10 ⁻¹⁰	O.F.H.C	SUS	—
87000-15	5KV-6-Cu-KV-G	5KV	145	10 ⁹	10 ⁻¹⁰	O.F.H.C	Fe-Ni-Co	Glazed
87000-18	5KV-6-Cu-KV	5KV	145	10 ⁹	10 ⁻¹⁰	O.F.H.C	Fe-Ni-Co	—

* 弊社での基礎評価、判定基準に基づいた参考値です。特性値は使用状況により異なる場合があります。
 Note that these numbers are meant as reference only and are based on our basic evaluation and set criteria.
 The numbers may vary depending on the product's usage.

Feedthroughs

[5KV-16]

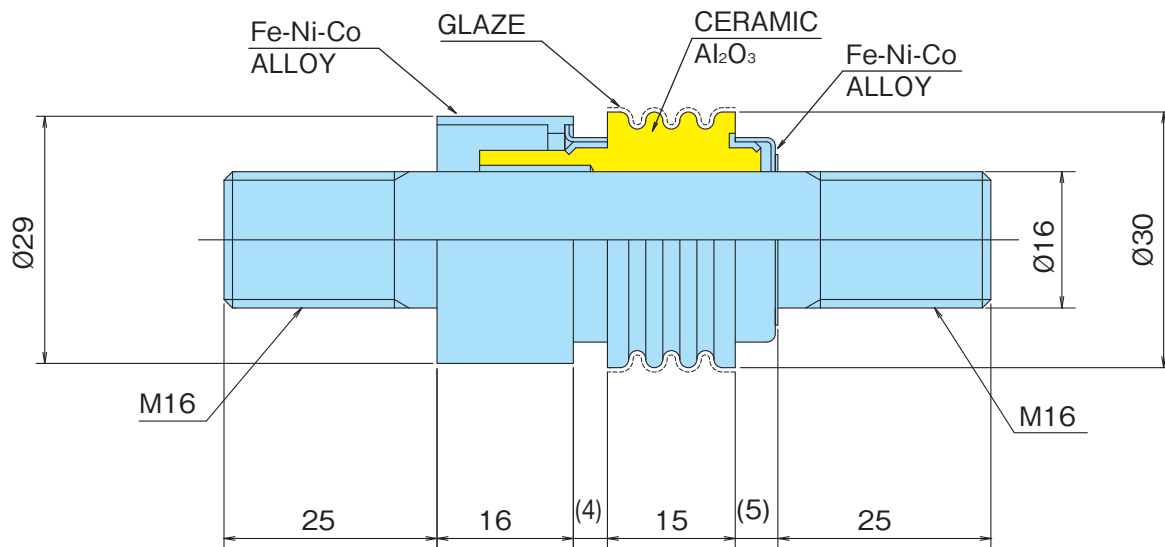

Part Number	TYPE	耐電圧 VOLTAGE [DC MAX]	許容電流値 Current [A MAX]	*絶縁抵抗 Insulation [Ω at DC500V]	気密性 Leak rate [1.3 × Pa·m ³ /s]	電極材質 Electrode	スリーブ材質 Sleeve	釉薬 Glaze
87000-26	5KV-16-SUS-SUS-G	5KV	73	10 ⁹	10 ⁻¹⁰	SUS	SUS	Glazed
87000-32	5KV-16-SUS-SUS	5KV	73	10 ⁹	10 ⁻¹⁰	SUS	SUS	—
87000-23	5KV-16-SUS-KV-G	5KV	73	10 ⁹	10 ⁻¹⁰	SUS	Fe-Ni-Co	Glazed
87000-29	5KV-16-SUS-KV	5KV	73	10 ⁹	10 ⁻¹⁰	SUS	Fe-Ni-Co	—
87000-25	5KV-16-KV-SUS-G	5KV	88	10 ⁹	10 ⁻¹⁰	Fe-Ni-Co	SUS	Glazed
87000-31	5KV-16-KV-SUS	5KV	88	10 ⁹	10 ⁻¹⁰	Fe-Ni-Co	SUS	—
87000-22	5KV-16-KV-KV-G	5KV	88	10 ⁹	10 ⁻¹⁰	Fe-Ni-Co	Fe-Ni-Co	Glazed
87000-28	5KV-16-KV-KV	5KV	88	10 ⁹	10 ⁻¹⁰	Fe-Ni-Co	Fe-Ni-Co	—
87000-27	5KV-16-Cu-SUS-G	5KV	476	10 ⁹	10 ⁻¹⁰	O.F.H.C	SUS	Glazed
87000-33	5KV-16-Cu-SUS	5KV	476	10 ⁹	10 ⁻¹⁰	O.F.H.C	SUS	—
87000-24	5KV-16-Cu-KV-G	5KV	476	10 ⁹	10 ⁻¹⁰	O.F.H.C	Fe-Ni-Co	Glazed
87000-30	5KV-16-Cu-KV	5KV	476	10 ⁹	10 ⁻¹⁰	O.F.H.C	Fe-Ni-Co	—

* 弊社での基礎評価、判定基準に基づいた参考値です。特性値は使用状況により異なる場合があります。
 Note that these numbers are meant as reference only and are based on our basic evaluation and set criteria.
 The numbers may vary depending on the product's usage.

[5KV-25]

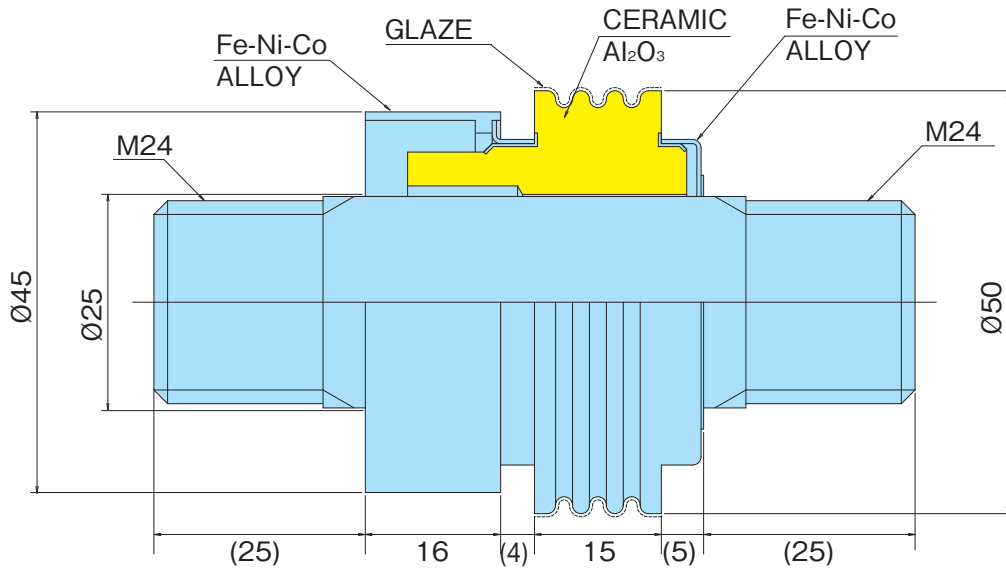

Part Number	TYPE	耐電圧 VOLTAGE [DC MAX]	許容電流値 Current [A MAX]	*絶縁抵抗 Insulation [Ω at DC500V]	気密性 Leak rate [1.3 × Pa·m ³ /s]	電極材質 Electrode	スリーブ材質 Sleeve	釉薬 Glaze
87000-38	5KV-25-SUS-SUS-G	5KV	124	10 ⁹	10 ⁻¹⁰	SUS	SUS	Glazed
87000-44	5KV-25-SUS-SUS	5KV	124	10 ⁹	10 ⁻¹⁰	SUS	SUS	—
87000-35	5KV-25-SUS-KV-G	5KV	124	10 ⁹	10 ⁻¹⁰	SUS	Fe-Ni-Co	Glazed
87000-41	5KV-25-SUS-KV	5KV	124	10 ⁹	10 ⁻¹⁰	SUS	Fe-Ni-Co	—
87000-37	5KV-25-KV-SUS-G	5KV	149	10 ⁹	10 ⁻¹⁰	Fe-Ni-Co	SUS	Glazed
87000-43	5KV-25-KV-SUS	5KV	149	10 ⁹	10 ⁻¹⁰	Fe-Ni-Co	SUS	—
87000-34	5KV-25-KV-KV-G	5KV	149	10 ⁹	10 ⁻¹⁰	Fe-Ni-Co	Fe-Ni-Co	Glazed
87000-40	5KV-25-KV-KV	5KV	149	10 ⁹	10 ⁻¹⁰	Fe-Ni-Co	Fe-Ni-Co	—
87000-39	5KV-25-Cu-SUS-G	5KV	808	10 ⁹	10 ⁻¹⁰	O.F.H.C	SUS	Glazed
87000-45	5KV-25-Cu-SUS	5KV	808	10 ⁹	10 ⁻¹⁰	O.F.H.C	SUS	—
87000-36	5KV-25-Cu-KV-G	5KV	808	10 ⁹	10 ⁻¹⁰	O.F.H.C	Fe-Ni-Co	Glazed
87000-42	5KV-25-Cu-KV	5KV	808	10 ⁹	10 ⁻¹⁰	O.F.H.C	Fe-Ni-Co	—

* 弊社での基礎評価、判定基準に基づいた参考値です。特性値は使用状況により異なる場合があります。
Note that these numbers are meant as reference only and are based on our basic evaluation and set criteria.
The numbers may vary depending on the product's usage.

Feedthroughs

[10KV-6]

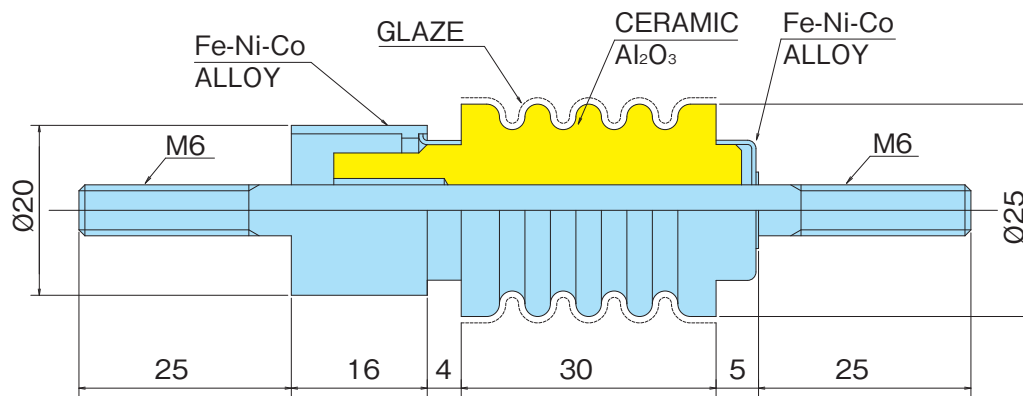

Part Number	TYPE	耐電圧 VOLTAGE [DC MAX]	許容電流値 Current [A MAX]	*絶縁抵抗 Insulation [Ω at DC500V]	気密性 Leak rate [1.3 × Pa·m ³ /s]	電極材質 Electrode	スリーブ材質 Sleeve	釉薬 Glaze
87000-7	10KV-6-SUS-SUS-G	10KV	22	10 ⁹	10 ⁻¹⁰	SUS	SUS	Glazed
87000-51	10KV-6-SUS-SUS	10KV	22	10 ⁹	10 ⁻¹⁰	SUS	SUS	—
87000-6	10KV-6-SUS-KV-G	10KV	22	10 ⁹	10 ⁻¹⁰	SUS	Fe-Ni-Co	Glazed
87000-48	10KV-6-SUS-KV	10KV	22	10 ⁹	10 ⁻¹⁰	SUS	Fe-Ni-Co	—
87000-46	10KV-6-KV-SUS-G	10KV	27	10 ⁹	10 ⁻¹⁰	Fe-Ni-Co	SUS	Glazed
87000-50	10KV-6-KV-SUS	10KV	27	10 ⁹	10 ⁻¹⁰	Fe-Ni-Co	SUS	—
87000-3	10KV-6-KV-KV-G	10KV	27	10 ⁹	10 ⁻¹⁰	Fe-Ni-Co	Fe-Ni-Co	Glazed
87000-47	10KV-6-KV-KV	10KV	27	10 ⁹	10 ⁻¹⁰	Fe-Ni-Co	Fe-Ni-Co	—
87000-2	10KV-6-Cu-SUS-G	10KV	145	10 ⁹	10 ⁻¹⁰	O.F.H.C	SUS	Glazed
87000-52	10KV-6-Cu-SUS	10KV	145	10 ⁹	10 ⁻¹⁰	O.F.H.C	SUS	—
87000-4	10KV-6-Cu-KV-G	10KV	145	10 ⁹	10 ⁻¹⁰	O.F.H.C	Fe-Ni-Co	Glazed
87000-49	10KV-6-Cu-KV	10KV	145	10 ⁹	10 ⁻¹⁰	O.F.H.C	Fe-Ni-Co	—

* 弊社での基礎評価、判定基準に基づいた参考値です。特性値は使用状況により異なる場合があります。
 Note that these numbers are meant as reference only and are based on our basic evaluation and set criteria.
 The numbers may vary depending on the product's usage.

Feedthroughs

[10KV-16]

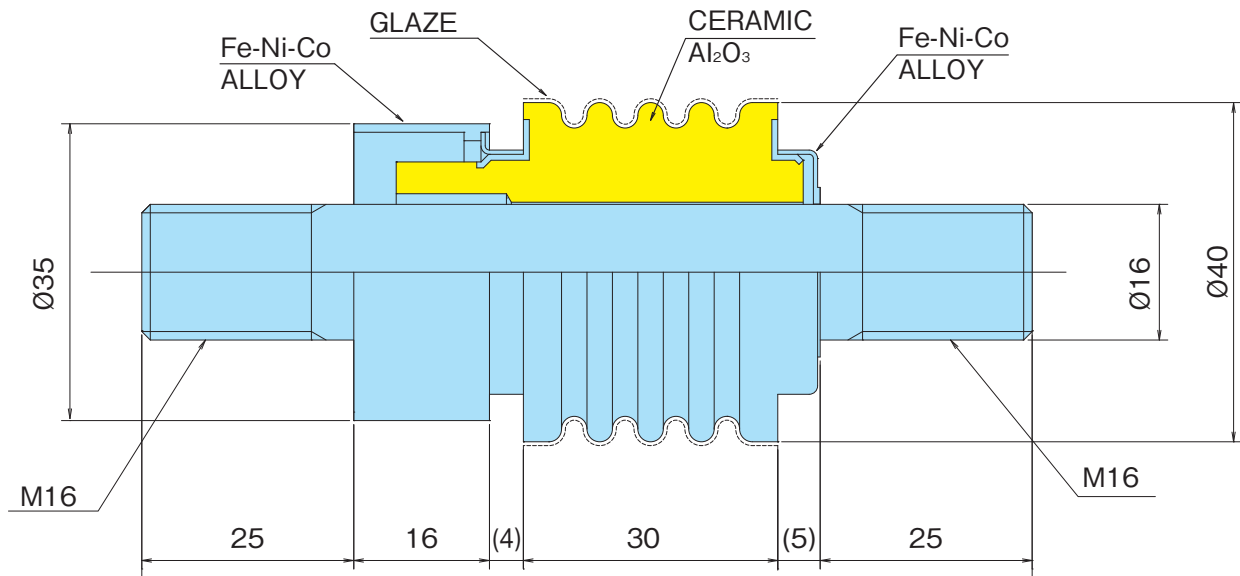

Part Number	TYPE	耐電圧 VOLTAGE [DC MAX]	許容電流値 Current [A MAX]	*絶縁抵抗 Insulation [Ω at DC500V]	気密性 Leak rate [1.3 × Pa·m ³ /s]	電極材質 Electrode	スリーブ材質 Sleeve	釉薬 Glaze
87000-5-06	10KV-16-SUS-SUS-G	10KV	73	10 ⁹	10 ⁻¹⁰	SUS	SUS	Glazed
87000-57	10KV-16-SUS-SUS	10KV	73	10 ⁹	10 ⁻¹⁰	SUS	SUS	—
87000-5-05	10KV-16-SUS-KV-G	10KV	73	10 ⁹	10 ⁻¹⁰	SUS	Fe-Ni-Co	Glazed
87000-54	10KV-16-SUS-KV	10KV	73	10 ⁹	10 ⁻¹⁰	SUS	Fe-Ni-Co	—
87000-5-02	10KV-16-KV-SUS-G	10KV	88	10 ⁹	10 ⁻¹⁰	Fe-Ni-Co	SUS	Glazed
87000-56	10KV-16-KV-SUS	10KV	88	10 ⁹	10 ⁻¹⁰	Fe-Ni-Co	SUS	—
87000-5-01	10KV-16-KV-KV-G	10KV	88	10 ⁹	10 ⁻¹⁰	Fe-Ni-Co	Fe-Ni-Co	Glazed
87000-53	10KV-16-KV-KV	10KV	88	10 ⁹	10 ⁻¹⁰	Fe-Ni-Co	Fe-Ni-Co	—
87000-5-04	10KV-16-Cu-SUS-G	10KV	476	10 ⁹	10 ⁻¹⁰	O.F.H.C	SUS	Glazed
87000-58	10KV-16-Cu-SUS	10KV	476	10 ⁹	10 ⁻¹⁰	O.F.H.C	SUS	—
87000-5-03	10KV-16-Cu-KV-G	10KV	476	10 ⁹	10 ⁻¹⁰	O.F.H.C	Fe-Ni-Co	Glazed
87000-55	10KV-16-Cu-KV	10KV	476	10 ⁹	10 ⁻¹⁰	O.F.H.C	Fe-Ni-Co	—

* 弊社での基礎評価、判定基準に基づいた参考値です。特性値は使用状況により異なる場合があります。
 Note that these numbers are meant as reference only and are based on our basic evaluation and set criteria.
 The numbers may vary depending on the product's usage.

Feedthroughs

[10KV-25]

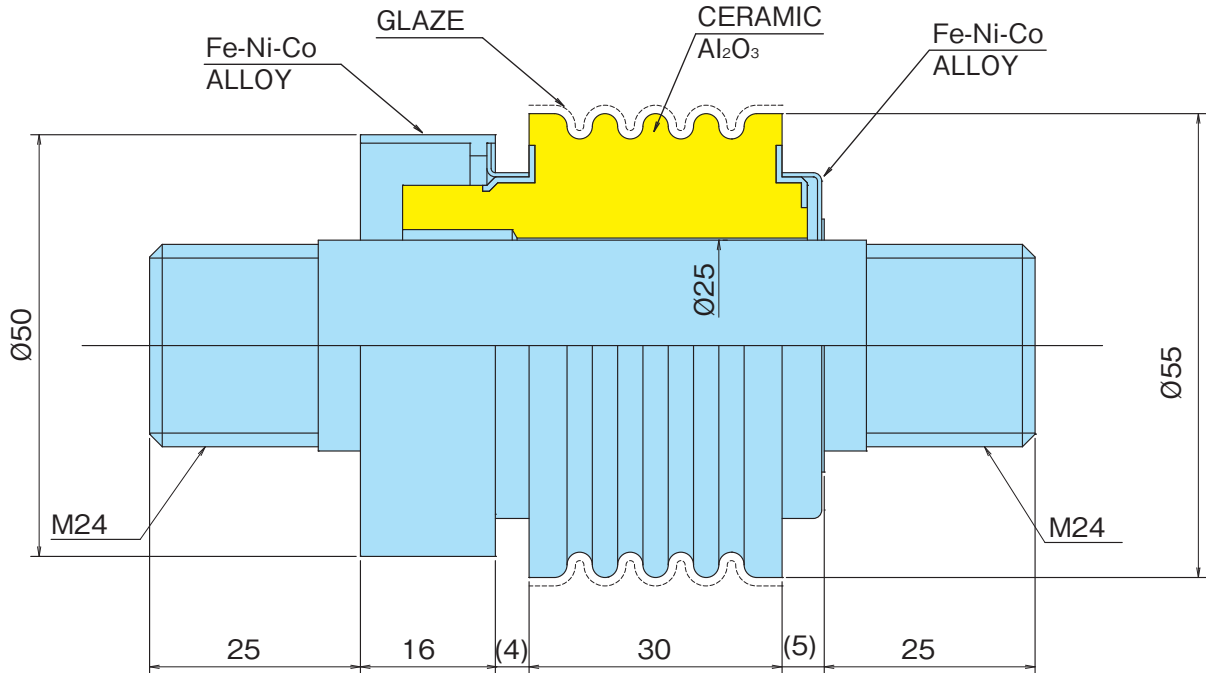

Part Number	TYPE	耐電圧 VOLTAGE [DC MAX]	許容電流値 Current [A MAX]	*絶縁抵抗 Insulation [Ω at DC500V]	気密性 Leak rate [1.3 × Pa·m ³ /s]	電極材質 Electrode	スリーブ材質 Sleeve	釉薬 Glaze
87000-63	10KV-25-SUS-SUS-G	10KV	124	10 ⁹	10 ⁻¹⁰	SUS	SUS	Glazed
87000-69	10KV-25-SUS-SUS	10KV	124	10 ⁹	10 ⁻¹⁰	SUS	SUS	—
87000-62	10KV-25-SUS-KV-G	10KV	124	10 ⁹	10 ⁻¹⁰	SUS	Fe-Ni-Co	Glazed
87000-68	10KV-25-SUS-KV	10KV	124	10 ⁹	10 ⁻¹⁰	SUS	Fe-Ni-Co	—
87000-61	10KV-25-KV-SUS-G	10KV	149	10 ⁹	10 ⁻¹⁰	Fe-Ni-Co	SUS	Glazed
87000-67	10KV-25-KV-SUS	10KV	149	10 ⁹	10 ⁻¹⁰	Fe-Ni-Co	SUS	—
87000-59	10KV-25-KV-KV-G	10KV	149	10 ⁹	10 ⁻¹⁰	Fe-Ni-Co	Fe-Ni-Co	Glazed
87000-66	10KV-25-KV-KV	10KV	149	10 ⁹	10 ⁻¹⁰	Fe-Ni-Co	Fe-Ni-Co	—
87000-65	10KV-25-Cu-SUS-G	10KV	808	10 ⁹	10 ⁻¹⁰	O.F.H.C	SUS	Glazed
87000-71	10KV-25-Cu-SUS	10KV	808	10 ⁹	10 ⁻¹⁰	O.F.H.C	SUS	—
87000-64	10KV-25-Cu-KV-G	10KV	808	10 ⁹	10 ⁻¹⁰	O.F.H.C	Fe-Ni-Co	Glazed
87000-70	10KV-25-Cu-KV	10KV	808	10 ⁹	10 ⁻¹⁰	O.F.H.C	Fe-Ni-Co	—

* 弊社での基礎評価、判定基準に基づいた参考値です。特性値は使用状況により異なる場合があります。
 Note that these numbers are meant as reference only and are based on our basic evaluation and set criteria.
 The numbers may vary depending on the product's usage.

Isolators

真空用の規格フランジに合わせた絶縁フランジです。
標準寸法その他、ご希望の電圧、用途に合わせたものが製造可能です。
Isolator flanges for vacuum application.
Standard sizes and custom made are available.

unit : mm

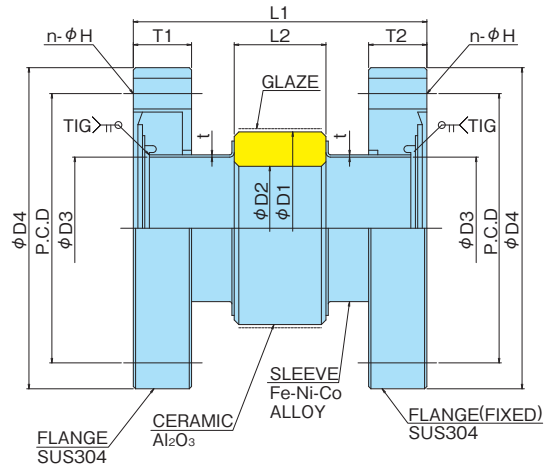
 参考値：沿面耐電圧 DC600V/mm
AC400V/mm

No	PART NAME(品名)	Part Number	耐電圧 Voltage [DC V max]	*絶縁抵抗 Insulation [Qmin.]	気密度 Leak rate [1.3xPa·m ³ /s]	*高温温度 Max. Temp. [deg. C]	*低温温度 Min. Temp. [deg. C]
A	ISOLATORS No.A	90283-1	6,000	10 ⁹	10 ⁻¹⁰	450	-196
B	ISOLATORS No.B	90283-2	12,000				
C	ISOLATORS No.C	90283-3	12,000				
D	ISOLATORS No.D	90283-4	24,000				
E	ISOLATORS No.E	90283-5	12,000				
F	ISOLATORS No.F	90283-6	24,000				
G	ISOLATORS No.G	90283-7	12,000				
H	ISOLATORS No.H	90283-8	24,000				
I	ISOLATORS No.I	90283-9	12,000				
J	ISOLATORS No.J	90283-10	24,000				
K	ISOLATORS No.K	90283-11	12,000				
L	ISOLATORS No.L	90283-12	24,000				

No	φD1	φD2	φD3	φD4	L1	L2	T1	T2	P.C.D	φH	n	t
A	25	14	15.4	34	60	10	7.5	7.5	27	4.5	6	0.5
B	25	14	15.4	34	70	20	7.5	7.5	27	4.5	6	0.5
C	42	27	29	70	62	20	12.7	12.7	58.7	6.7	6	0.5
D	42	27	29	70	82	40	12.7	12.7	58.7	6.7	6	0.5
E	70	56	58.5	114	80	20	19	17.5	92.2	8.4	8	0.5
F	70	56	58.5	114	100	40	19	17.5	92.2	8.4	8	0.5
G	100	75	76.5	152	95	20	21	20	130.3	8.4	16	0.75
H	100	75	76.5	152	115	40	21	20	130.3	8.4	16	0.75
I	148	122	101.5	203	105	20	24	22	181.1	8.4	20	0.75
J	148	122	101.5	203	125	40	24	22	181.1	8.4	20	0.75
K	190	135	136	253	110	20	25	25	231.9	8.4	24	1.0
L	190	135	136	253	130	40	25	25	231.9	8.4	24	1.0

* 弊社での基礎評価、判定基準に基づいた参考値です。特性値は使用状況により異なる場合があります。
Note that these numbers are meant as reference only and are based on our basic evaluation and set criteria.
The numbers may vary depending on the product's usage.

Isolators with Bellows

真空用の規格フランジに合わせた絶縁フランジです。
 標準寸法その他、ご希望の電圧、用途に合わせたものが製造可能です。
 Isolator flanges for vacuum application.
 Standard sizes and custom made are available.

unit : mm

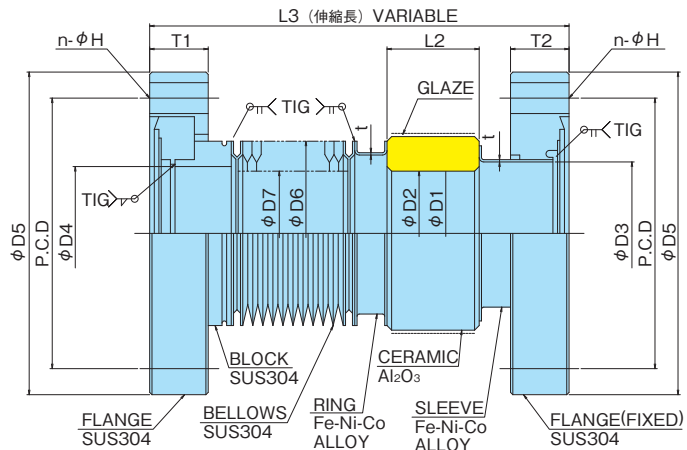
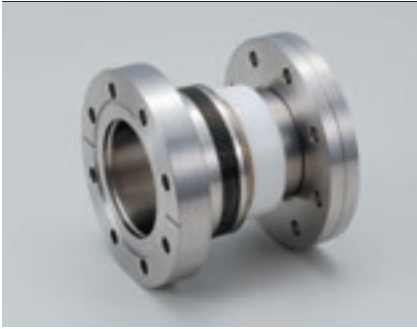

参考値 : 沿面耐電圧
 DC600V/mm
 AC400V/mm

No	PART NAME(品名)	Part Number	No	T1	T2	P.C.D	H	n	t
A	ISOLATORS WITH BELLOWS No.A	90284-1	A	7.5	7.5	27	4.5	6	0.5
B	ISOLATORS WITH BELLOWS No.B	90284-2	B	7.5	7.5	27	4.5	6	0.5
C	ISOLATORS WITH BELLOWS No.C	90284-3	C	12.7	12.7	58.7	6.7	6	0.5
D	ISOLATORS WITH BELLOWS No.D	90284-4	D	12.7	12.7	58.7	6.7	6	0.5
E	ISOLATORS WITH BELLOWS No.E	90284-5	E	19	17.5	92.2	8.4	8	0.5
F	ISOLATORS WITH BELLOWS No.F	90284-6	F	19	17.5	92.2	8.4	8	0.5
G	ISOLATORS WITH BELLOWS No.G	90284-7	G	21	20	130.3	8.4	16	0.75
H	ISOLATORS WITH BELLOWS No.H	90284-8	H	21	20	130.3	8.4	16	0.75
I	ISOLATORS WITH BELLOWS No.I	90284-9	I	24	22	181.1	8.4	20	0.75
J	ISOLATORS WITH BELLOWS No.J	90284-10	J	24	22	181.1	8.4	20	0.75
K	ISOLATORS WITH BELLOWS No.K	90284-11	K	25	25	231.9	8.4	24	1.0
L	ISOLATORS WITH BELLOWS No.L	90284-12	L	25	25	231.9	8.4	24	1.0

No	φD1	φD2	φD3	φD4	φD5	φD6	φD7	L2	L3
A	25	14	15.4	14	34	26	12	10	63~71
B	25	14	15.4	14	34	26	12	20	71~79
C	42	27	29	31	70	40	27	20	88.5~96.5
D	42	27	29	31	70	40	27	40	108.5~116.5
E	70	56	58.5	60.5	114	80	60	20	100.5~108.5
F	70	56	58.5	60.5	114	80	60	40	120.5~128.5
G	100	75	76.5	79.5	152	100	75	20	105.5~113.5
H	100	75	76.5	79.5	152	100	75	40	125.5~133.5
I	148	122	101.5	104.5	203	162	132	20	118~126
J	148	122	101.5	104.5	203	162	132	40	138~147
K	190	135	136	140	253	185	135	20	117~125
L	190	135	136	140	253	185	135	40	137~145

No. A, B, E, F
 は内側からボルトが
 入りません。
 ナットの使用のみと
 なります。
 No. A, B, E, F
 apply Only nut no
 bolt from inside.

Sapphire Windows

単結晶サファイアを使った覗き窓です。真空用の規格フランジに合わせたサイズのほか、耐圧用の窓の製作も行います。光学用の計測窓には、無反射コーティングを行うこともできます。
Single crystal sapphire is used. AR coating is option.

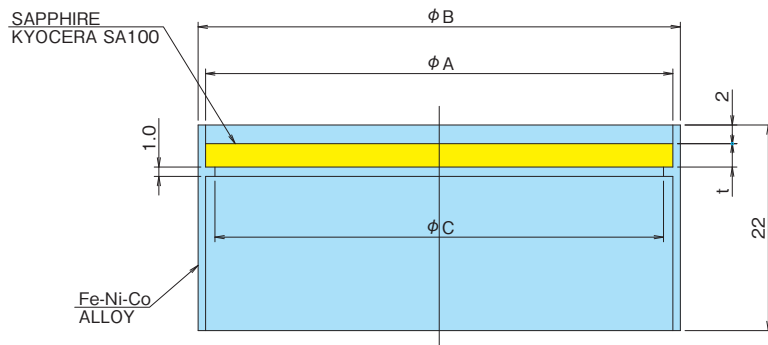

unit : mm

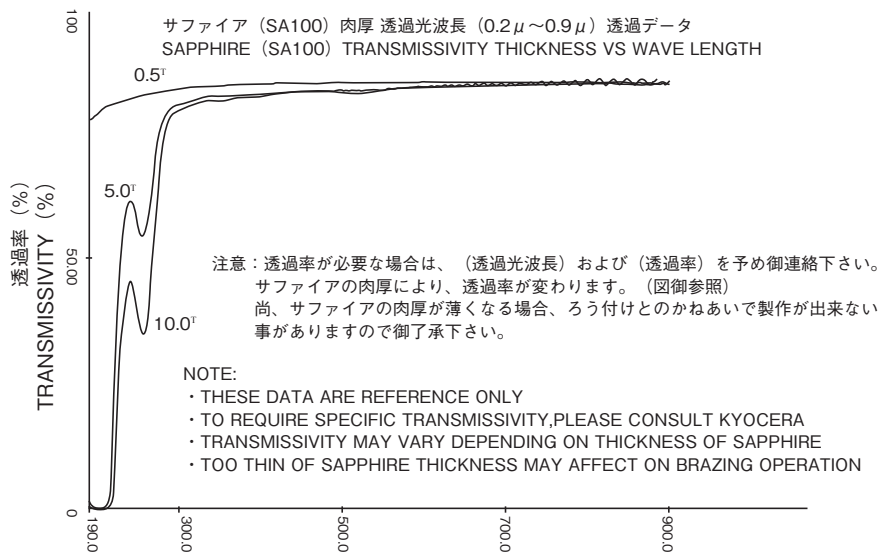

Part Number	PART NAME(φ) mm・名称	A	B	C	t
90167-1	SAPPHIRE WINDOWS φ20	20	21.6	18	2
90167-2	SAPPHIRE WINDOWS φ30	30	31.6	28	2
90167-3	SAPPHIRE WINDOWS φ35	35	36.6	33	2.5
90167-4	SAPPHIRE WINDOWS φ40	40	41.6	38	2.5
90167-5	SAPPHIRE WINDOWS φ50	50	51.6	48	2.5
90167-6	SAPPHIRE WINDOWS φ60	60	61.6	58	3
90167-7	SAPPHIRE WINDOWS φ70	70	71.6	68	3
90167-8	SAPPHIRE WINDOWS φ80	80	81.6	78	3
90167-9	SAPPHIRE WINDOWS φ100	100	101.6	98	4
90167-10	SAPPHIRE WINDOWS φ150	150	151.6	148	4

Sapphire Windows with Vacuum Flange

真空用フランジ（コンフラットフランジ）にサファイア窓を取りつけたものです。真空装置にこのまま取り付けて使用して頂けます。

Products for vacuum Flange (ConFlat Flange) assembled with sapphire windows.

They can be used by attaching them directly to vacuum equipment.

unit : mm

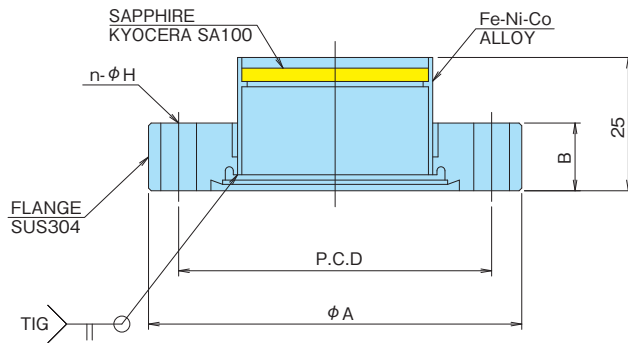

Part Number	PART NAME・名称	A	B	n	H	P.C.D
90170-1	70F SW35	70	12.7	6	6.7	58.7
90170-2	114F SW70	114	17.5	8	8.4	92.2
90170-3	152F SW100	152	20	16	8.4	130.3
90170-4	203F SW150	203	22	20	8.4	181.1

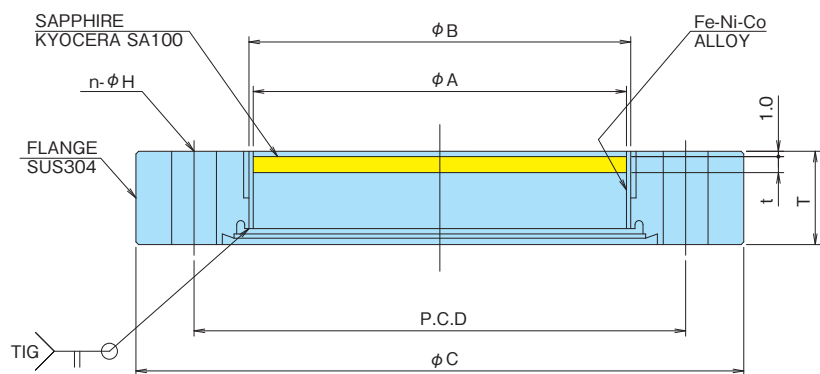

Part Number	PART NAME・名称	A	B	C	t	T	n	H	P.C.D
97111	70F SW35S	35	36.6	70	2.5	12.7	6	6.7	58.7
90173-1	114F SW70S	70	71.6	114	3	17.5	8	8.4	92.2
90173-2	152F SW100S	100	101.6	152	4	20	16	8.4	130.3
90173-3	203F SW150S	150	151.6	203	4	22	20	8.4	181.1

Introducing New Technology

D-sub セラミック真空気密端子（ロウ付け接合品）

Hermetic Subminiature D type Ceramic Feedthroughs

超高真空用途で使用可能なセラミックによる D-sub 真空気密端子です。
MIL-C-24308 に相当した製品が製作可能です。

Subminiature D type Ceramic Feedthroughs have good hermetic properties for Ultra High Vacuum Application.
The Feedthroughs are equivalent to MIL-C-24308.

9 PIN



15 PIN



25 PIN

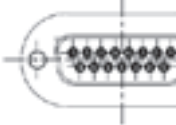
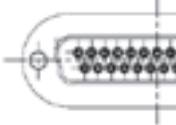

■ 特性表 Characteristics

項目 Items	単位 Unit	PIN Type		
		9 PIN	15 PIN	25 PIN
大きさ Size (W · H · L)	mm	 31.3 x 18.3 x 22.0	 39.7 x 18.3 x 22.0	 53.3 x 18.3 x 22.0
許容電流値 Current	A/Pin max.	3		
耐電圧 Voltage	V max	DC 300		
気密度 Leak Rate	1.3xPa·m ³ /s	10 ⁻¹⁰		
*絶縁抵抗 Insulation	Ω min.	10 ⁹		

* 弊社での基礎評価、判定基準に基づいた参考値です。特性値は使用状況により異なる場合があります。
Note that these numbers are meant as reference only and are based on our basic evaluation and set criteria.
The numbers may vary depending on the product's usage.

Introducing New Technology

液体水素対応気密部品

Hermetic Connectors for Liquid Hydrogen Environment

京セラは宇宙航空研究開発機構（JAXA）様との共同研究により液体水素（ -253°C ）環境下で使用可能な気密部品を開発しました。水素社会の実現に貢献してまいります。

Kyocera developed hermetic connectors that can be used in a liquid hydrogen (-253°C) environment through collaboration and joint research with the Japan Aerospace Exploration Agency (JAXA). Kyocera will continue to contribute to the realization of a hydrogen future.

特長

Features

- 極低温の厳しい温度サイクル試験に合格
Successfully passed cooling cycle test under severe cryogenic temperature conditions.

用途

Applications

- 宇宙ロケット搭載タンクや地上設備タンク用
For space rocket tanks and ground equipment tanks.
- 液体水素運搬船タンクや荷揚げ基地タンク用
For liquid hydrogen carrier tanks and unloading base tanks.
- 液体水素モビリティやエネルギーシステムなど
For liquid hydrogen mobility, energy systems, etc.

■ SMA タイプ SMA_Type



© 宇宙航空研究開発機構 (JAXA)

■ 京セラ開発品 Kyocera Developed Product



10-pin



48-pin

■ 常圧水素環境下での耐久性確認

Verified data from rapid cooling cycle test between liquid hydrogen and ambient.

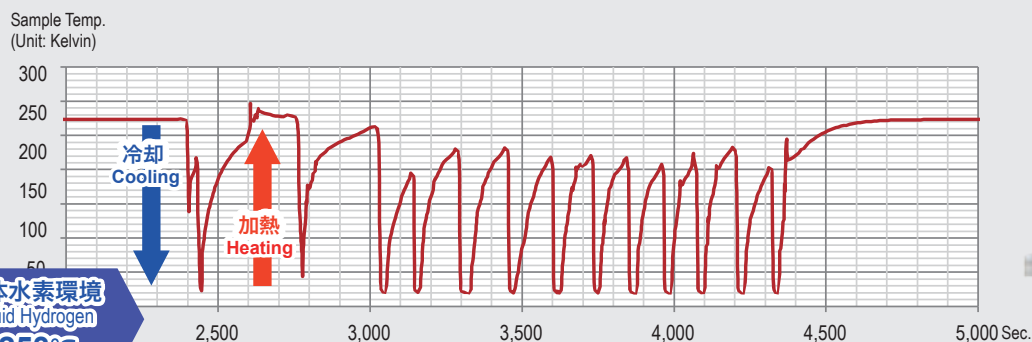

急速膨張試験 (提供: JAXA)
Rapid Cooling -Heating Cycle Test (Provision of data: JAXA)



* カスタム設計となりますので、随時お問い合わせください。

All hermetic connectors for liquid hydrogen are custom-designed. Please contact us for more details.

Introducing New Technology

非磁性金属とのロウ付け接合品

Non-magnetic Feedthroughs

京セラは、銅 (Cu) やチタン (Ti) など非磁性金属とのロウ付け技術により、非磁性の超高真空気密端子の製作が可能です。この気密端子は、超電導・加速器など強い磁界の分野で広く利用されており、磁界への影響の抑制に貢献しております。

Kyocera's brazing technology with non-magnetic metals such as copper (Cu) and titanium (Ti) enables the production of non-magnetic ultra-high vacuum feedthroughs. These feedthroughs are widely used in the strong magnetic fields such as superconductivity and accelerators, and contribute to reducing the influence on magnetic fields.

■ 非磁性金属への変更例 [標準品 N-R]

Example of change to non-magnetic metal

Electrode: [非磁性金属] 銅(Cu)、チタン(Ti)など
Non-magnetic metal: Cu or Ti, etc.

Sleeve: [非磁性金属] チタン(Ti)など
Non-magnetic metal: Ti, etc.

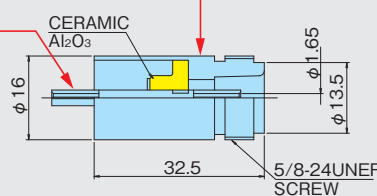

* 非磁性金属については、製作できる組み合わせがあります。詳細についてはお問合せ下さい。
For non-magnetic metals, various combinations can be made. Please contact us for details.

アルミニウム金属とのロウ付け接合品

Feedthrough with Aluminum Metal

京セラは、耐腐食性・熱伝導率に優れたアルミニウム金属へのロウ付け技術を有しております。京セラ標準品をアルミニウム金属へ変更可能です。

Aluminum metal with excellent corrosion resistance and thermal conductivity can also be brazed. The metal parts of our standard products can be changed to aluminum metal.

■ アルミニウム金属への変更例 [標準品 BNC-R]

Example of change to aluminum metal

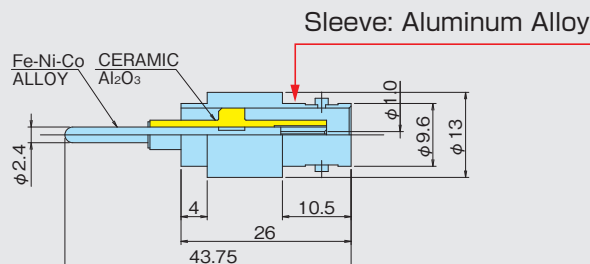

* 製作できる組み合わせがあります。詳細についてはお問合せ下さい。
Various combinations can be made. Please contact us for details.

Introducing New Technology

高周波窓用セラミックス

RF Window Ceramics

MHz、GHzといった高周波帯域のRF窓用部材には、誘電損失の低いセラミック材料が使用されています。京セラでは、従来のセラミック材料に加え、より低い誘電損失の材料 (AO479B, AO479U, SN287A) をラインナップし、幅広い周波数帯でのご要求にお応え致します。

MHz and GHz high frequency RF windows utilize low dielectric loss ceramics. In addition to conventional ceramic materials, Kyocera offers additional lines of low loss materials (AO479B, AO479U, SN287A) to support demands in wide range of frequency applications.

特長

Features

- 用途、要求特性に応じた材料提案
Applications specific & custom material options

用途

Application

- 高周波帯域のRF窓用部材
RF window components for the high-frequency applications

材料特性表 Material Characteristics

項目 Item	単位 Unit	アルミナ Al ₂ O ₃					窒化ケイ素 Si ₃ N ₄	
		AO4730	AO4760	AO4790	AO479B	AO479U	SN287A	
熱伝導率 (20°C) Thermal Conductivity	W/mK	18	24	29	29	32	59	
比誘電率 Dielectric Constant	-	9.0	9.4	9.9	9.9	10	7.8-8.0	
誘電正接 ^{*1} Dielectric Loss Tangent	1MHz	x10 ⁻⁴	6	4	2	1	<1	-
	1GHz	x10 ⁻⁴	19	17	15	<10	-	-
	3.2GHz 付近	x10 ⁻⁴	7.6	5.5	1.5	0.3	0.3	0.4-0.6
	8.5GHz 付近	x10 ⁻⁴	10	6.4	2	0.4	0.4	-
	10GHz 付近	x10 ⁻⁴	-	-	-	-	-	0.7-0.9
	30GHz 付近	x10 ⁻⁴	-	-	-	-	-	1.0-1.2
35GHz 付近	x10 ⁻⁴	-	-	-	-	2.1	-	
3点曲げ強さ Flexural Strength (3 pts)	MPa	340	350	310	300	380	730	



円板 Discs



ドーナツ形状 Doughnut shape



シリンダー形状 Cylinders

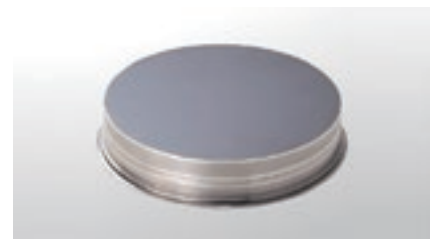

金属部品ロウ付け Metal Brazing

*1 誘電正接測定方法：1GHz: 高周波電流電圧法 / 3.2GHz 付近: 誘電体装荷空洞共振法 / 8.5GHz 付近: 円柱共振法
Dielectric loss measurement method : 1GHz: High-frequency current-voltage method / around 3.2GHz: Dielectric loaded cavity resonance method
around 8.5GHz: Cylindrical resonance method

*2 上記特性値はテストピースの測定による参考値です。特性値は製品の形状や使用条件により異なる場合があります。
The above tables are in reference values to test piece measurement. Material characteristics are subject to change based on product design and usage. These values are unique to our experimental test data and may not be guaranteed.

Introducing New Technology

高沿面耐電圧アルミナ材料 (AH100A)

High Voltage-resistant Alumina Ceramic

従来より、耐電圧性能が高いアルミナセラミックスは、高電圧装置に広く使用されています。京セラは、さらに沿面耐電圧特性を向上させた新材料“AH100A”を開発いたしました。AH100Aは、従来材料と比較して、1.6倍の沿面耐電圧、1.2倍の貫通耐電圧の特性を有し、高電圧のコンディショニング時間の削減や、端子の小型化が可能となります。

Alumina is widely used in high-voltage equipment because of its high resistance to voltage. AH100A has a creepage withstand voltage 1.6 times higher and a penetration withstand voltage 1.2 times higher than those of conventional Kyocera alumina materials in vacuum. It also reduces high-voltage conditioning time. Because of these advantages, in some cases we have reduced the size of the product by 50%.

特長

Features

- 真空中の沿面耐電圧、及び貫通耐電圧性能を大幅に向上
Improvement of dielectric strength / creeping voltage resistance in vacuum atmosphere
- 高電圧コンディショニング時間大幅短縮
Conditioning time reduction at high voltage operation
- 従来比 50% の小型化を実現*
50% downsizing from conventional alumina* (*京セラ試算 based on Kyocera simulation)

材料特性表

Material Characteristics & Measurement Comparison

項目 Items		単位 Unit	AO4790	AH100A
電気的特性 Electrical Characteristics	到達電界強度 Reached Electric Field Strength	MV/m	8.4 (ave.)	14.1 (ave.)
	貫通耐電圧 Penetration Withstand Voltage	MV/m	19	24
	体積固有抵抗 Volume Resistivity	$\Omega \cdot \text{cm}$	$\geq 1 \times 10^{14}$	$\geq 1 \times 10^{14}$
	比誘電率 (1MHz) Dielectric Constant	-	9.9	10.2
	誘電正接 (1MHz) Dielectric Loss Angle	-	2×10^{-4}	$< 1 \times 10^{-4}$
機械的特性 Mechanical Characteristics	平均強度 ASTM D2442 TYPE3 Average Strength	MPa	310	330
	ヤング率 Young's Modulus of Elasticity	GPa	360	380
	ポアソン比 Poisson's Ratio	-	0.23	0.25
	破壊靱性 Fracture Toughness	$\text{MPa} \cdot \text{m}^{1/2}$	3~4	5
熱的特性 Thermal Characteristics	熱伝導率 Thermal Conductivity	W/mK	29	24
	熱膨張係数 (RT-800°C) Coefficient of Thermal Expansion	ppm/°C	8.0	8.2

< 数値は比較・参考値 (Reference Data) >



小型化デザインのイメージ Design Image of Size Reduction



コンディショニング時間 Conditioning Time

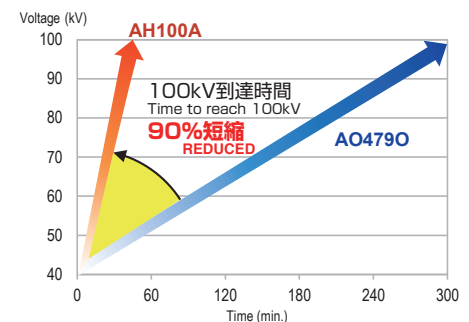

測定条件: 圧力10⁻³Pa以下
昇電圧1kV/mm
フラッシュオーバーが起きると、0Vから再昇電圧
Measuring Pressure 10⁻³Pa
Conditions: Voltage Increase 1kV/min.
Restarted from 0V every time flashover voltage is observed

効果を発揮する条件 Conditions for effectiveness

放電 Electrical discharge	大気 Atmosphere	真空 Vacuum
空中 Air		
沿面 Creep		
貫通 Penetration		有効範囲 Scope

Introducing New Technology

30kV 高電圧用端子

30kV Feedthroughs

高電圧電流導入端子は、一定の沿面距離が必要になるのでセラミックが大型になります。京セラの新 30kV 端子は専用シリコン絶縁ケーブルを利用することで、従来品より小型化を実現しました。接続フランジは、NW/KF, ICF 規格から選択可能です。

High-voltage feedthroughs require larger ceramics to allocate sufficient creepage distance. Kyocera's new 30KV feedthroughs have achieved a smaller size compared to conventional models through innovation in customized silicon insulation cables. We provide options in NW/KF and ICF standards for our custom connector flange.

■ 電流導入端子の特性表 *1

Characteristics of Feedthrough

電極材質 Electrode Material	Fe-Ni-Co	SUS316L
許容電流値 Current [A max]	3	2
耐電圧 Voltage [V max]	30KV	
絶縁抵抗 IR [Ω at DC.500 V]	10 ⁹	
気密性 Leak Rate [1.3 x Pa · m ³ /s]	10 ⁻¹⁰	



端子
Feedthrough



フランジ付き端子
Feedthrough with Flange



端子寸法
Feedthrough dimensions

小型化デザインのイメージ Design Image of Size Reduction

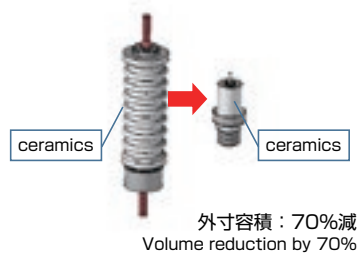

■ 実験データ：耐電圧試験結果 Reference Data: Withstand Voltage Test Result

30分で50kVまで昇圧を確認
Conditioning time to 50kV in 30 minutes

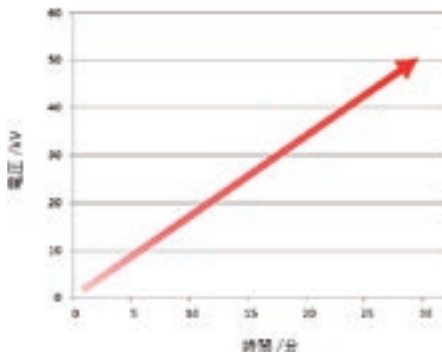

30分間、40kVキープで放電しないことを確認
No electrical discharge for 30 minutes at 40kV

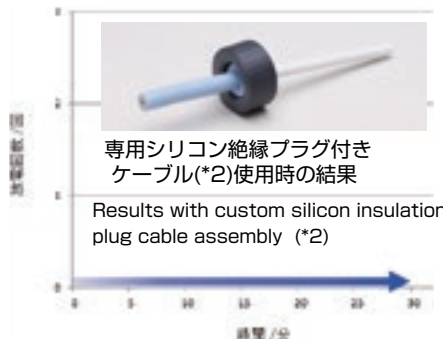

専用ケーブル実装写真
Image of the special cable installation

*1 上記特性表は、弊社での基礎評価、判定基準に基づいた参考値です。特性値は使用状況により異なる場合があります。またデータは実験データであり、保証するものではありません。

*1 The above tables are reference values based on our evaluations. Values may vary depending on usage conditions. These values are unique to our experimental test data and may not be guaranteed.

*2 コスモ・テック株式会社製：型式 ASP-30KV2500 (ケーブル長 2.5m)、型式 ASP-30KV5000 (ケーブル長 5m)

*2 Made by COSMOTEC Corporation : model ASP-30KV2500 (cable length 2.5m), model ASP-30KV5000 (cable length 5m)

Introducing New Technology

BPM(Beam Position Monitor)

ビーム位置モニターは、粒子ビームの位置を正確に測定し、制御するために不可欠な役割を果たします。京セラは、高精度で、安定した特性インピーダンスを保有したBPMを提供することができます。またTDR測定やキャパシタンスも計測が可能です。

Beam position monitors play an essential role in accurately measuring and controlling the position of a particle beam. Kyocera can provide high accuracy BPMs with stable characteristic impedance. TDR and capacitance measurements are also available upon request.

特長 Features

項目 Service	セラミックロウ付け接合 Ceramic Brazed Joining
設計自由度 Design Flexibility	実績が豊富で、セラミック&接合の強度が高いため周辺部品との接合設計が容易 Design flexibility with peripheral components due to extensive track record of high strength in ceramic and bonding assembly.
機械的強度 Mechanical Strength	超高真空中高い気密性を確保 High hermiticity in Ultra-high vacuum
製品性能 Product Performance	絶縁抵抗が高く、ハイパワーの電力で利用に有利 High voltage standoff performance in high power electric applications.
オプション対応 Option	非磁性対応金属 (Cu/Ti) との接合 Bonding options with non-magnetic metals (Cu/Ti).
フランジ取付 Flange Mounting	形状、材質に応じて溶接・ロウ付けにて接合 * 客先でフランジ溶接は応力への配慮要 *Thermal stress shall be considered in flange welding at customer site.
測定 Measurement	TDR・キャパシタンス測定によるソーティングが可能 Sorting by TDR and capacitance measurement available.



©高エネルギー加速器研究機構(KEK)



Spring-8-II用RIKEN様開発品
©RIKEN Spring-8 Center

■ 材料特性表及び仕様例

Material Characteristics and Examples of Specifications

項目 Characteristics/Specifications		セラミックロウ付け接合 Ceramic Brazed Joining	
素材 material	材質 Material Code	A0479S	
	機械的特性 Mechanical Characteristics	3点曲げ強さ 3-Point Bending Strength	400MPa
		絶縁破壊強さ Dielectric Strength	15kV/mm
	電気的特性 Electrical Characteristics	比誘電率 (1 MHz) Dielectric Constant	9.9
誘電正接 (1 MHz) Dielectric Loss Angle		1×10^{-4}	
気密性 Hermiticity		$1 \times 10^{-11} \text{Pa} \cdot \text{m}^3/\text{s} (\text{He})$	
インピーダンスマッチング Impedance Matching		50 Ω	
ベーキング温度 Baking Temperature		300°C Max	

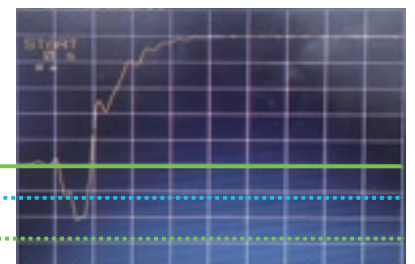

TDR Measurement

Introducing New Technology

サファイア気密部品

Sapphire Hermetic Components

京セラは、サファイアを絶縁部として用いた気密部品の製造が可能です。

Kyocera can manufacture state of the art sapphire insulator to hermetic components.

特長

Features

- サファイアは低温領域で高い熱伝導率の特性を持つ絶縁体
Sapphire is an insulating material with high thermal conductivity that is suitable in low temperature ranges.
- 高純度ニオブ (RRR > 300) その他金属とのロウ付けが可能。
High purity niobium (RRR>300) and other metal options available for brazing assembly.
- サファイアは自社製造
Kyocera grown sapphire from raw material to crystallization.
- 非磁性金属の対応も可能です。
Non-magnetic metal options available.



サファイア気密端子
Sapphire Feedthrough

用途

Applications

- 超電導加速空洞用 HOM アンテナ
HOM antenna for Superconducting Accelerator Cavity.
- 液体水素燃料用窓
Windows for liquid hydrogen fuel.

■ 低温熱伝導率

Low Temperature Thermal Conductivity

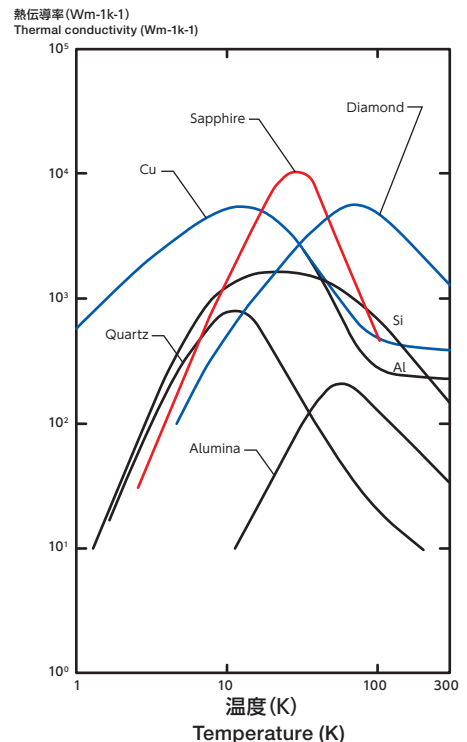

Reference: E.Tward・R.Kirschman,
「Proceedings of the Cold Electronics Workshop」,
1984、p12

*1 右のグラフの熱伝導率の値は文献による参考値です。
保証値ではありません。

*1 The thermal conductivity values are for references only.
These values are not guaranteed.

Topics

高電圧ソリューション（セラミック材料・設計・評価）

High Voltage Solutions (Ceramic Materials, Design and Evaluation)

京セラは長年にわたり、数多くの高電圧（30kV以上）対応セラミック電流導入端子を、お客様の求める仕様に合わせて製作してきました。その中で培われた設計・シミュレーション技術、より高電圧に対応するために開発されたセラミック材料、多種多様な製品形状・仕様に対応した性能評価体制を備え、お客様の高電圧に対する様々な課題にお応えします。

Kyocera manufactures many high-voltage (30kV or higher) ceramics. With our design and simulation technologies and ceramic materials developed for high voltage applications, we are able to meet our customers' requirements.

■ 京セラの3つのサポート Three solutions from Kyocera

〈高電圧部品に求められるニーズ〉

- 高電圧の安定維持
Stabilization of high voltage
- コンディショニング時間の短縮
Reduction of the conditioning time
- 小型化・省スペース
Miniaturization and space saving
- リーク電流の低減
Reduction of leakage current
- 長寿命化
Longer lifetime

〈京セラのサポート〉

1. 高電圧セラミック部品の設計技術
Design technology for high-voltage ceramic components
2. 高電圧製品の性能評価
Performance evaluation of high-voltage products
3. 用途に合わせた最適な材料提案
Optimal material proposal for specific applications

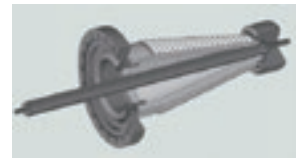

高圧耐電圧アルミナ（AH100A）のページを参照ください。
Please refer to the page of High Voltage-resistant Alumina Ceramic (AH100A).

1. 高電圧セラミック部品の設計技術 Design technology for high voltage ceramic components

電界シミュレーションによる製品の最適化
Design optimization through electric field simulations

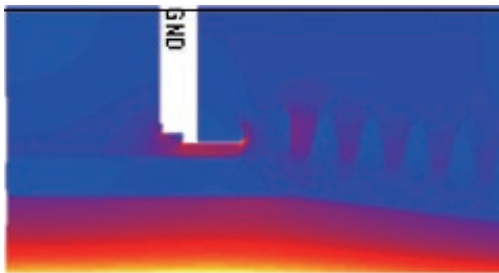

電界シミュレーション
Electric Field Simulation

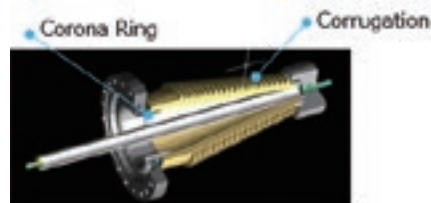

- コルゲーションによる沿面耐電圧向上
Improvement of creeping voltage by corrugation
- コロナリングによる電界緩和
Electric field mitigation by corona ring
- アルミナの選定（誘電率・抵抗率）
Selection of Alumina
- メタライズ範囲の最適化（電界緩和）
Optimization of metallization range

2. 高電圧製品の性能評価 Performance evaluation of high-voltage products

■ High voltage DC testing

京セラでは、MAX DC120kVまでテスト可能です。
Kyocera can test up to 120kV DC MAX.

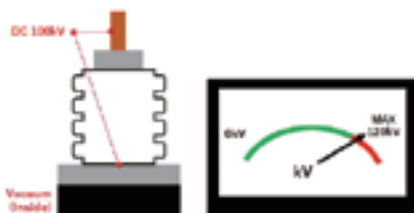

■ Helium leak test

Hermeticity : <math> < 1.0 \times 10^{-10} \text{ Pa} \cdot \text{m}^3/\text{s}</math>

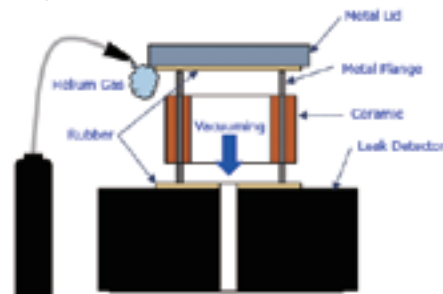

◆ 新たに京セラグループに加入した関連会社製品のご紹介

New Subsidiary Company of the Kyocera Group

KYOCERA Fineceramics Europe GmbH Mannheim Plant

1863年設立 2019年から京セラの一員となったドイツのセラミックメーカーです。

Established in 1863, a German ceramics manufacturer that has been a member of Kyocera since 2019.

金属とセラミックスの接合 Joining Metal and Ceramics

KYOCERA Fineceramics Europe GmbH has years of experience in manufacturing ceramic-to-metal customized and serial components for ultra-high vacuum applications specialising in various brazing techniques.

製品例

Product Examples

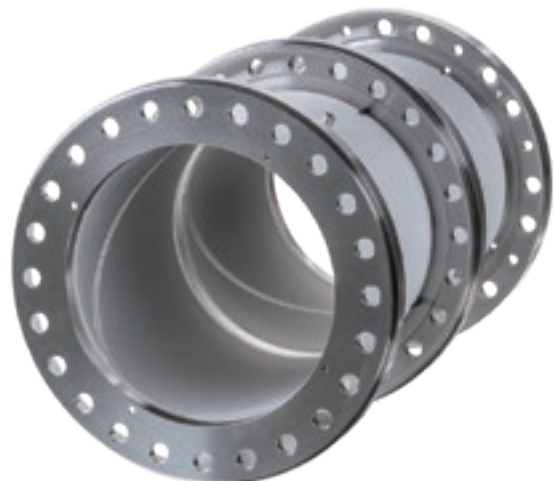

Custom-designed Ceramic Chambers

unit : mm



by courtesy of Pohang University of Science and Technology



by courtesy of High Energy Accelerator Research Organization

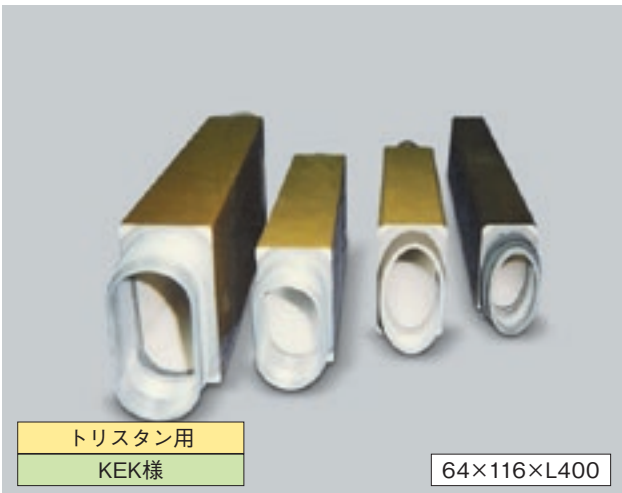

by courtesy of High Energy Accelerator Research Organization
Application: TRISTAN

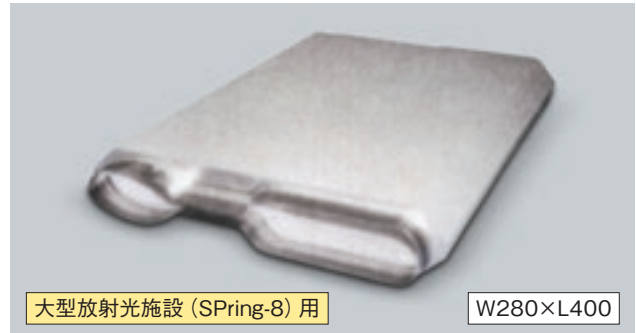

Application: SPring-8



by courtesy of High Energy Accelerator Research Organization

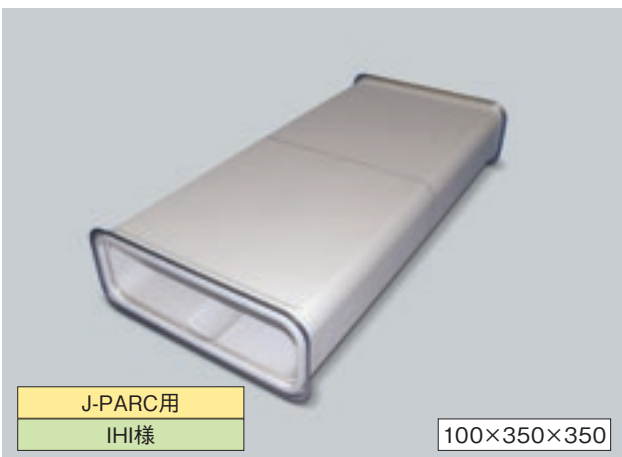

by courtesy of Ishikawajima-Harima Heavy Industries Co.,Ltd
Application: J-PARC

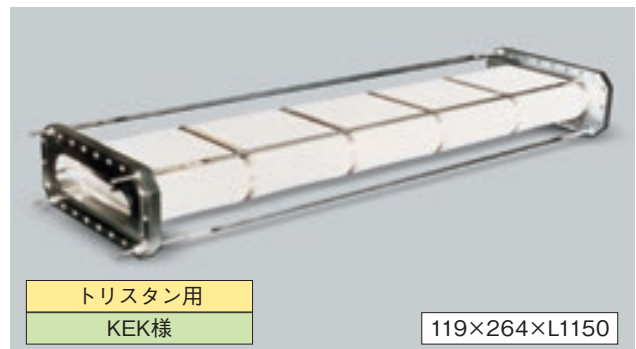

by courtesy of High Energy Accelerator Research Organization
Application: TRISTAN

Custom-designed Isolator Flanges

unit : mm

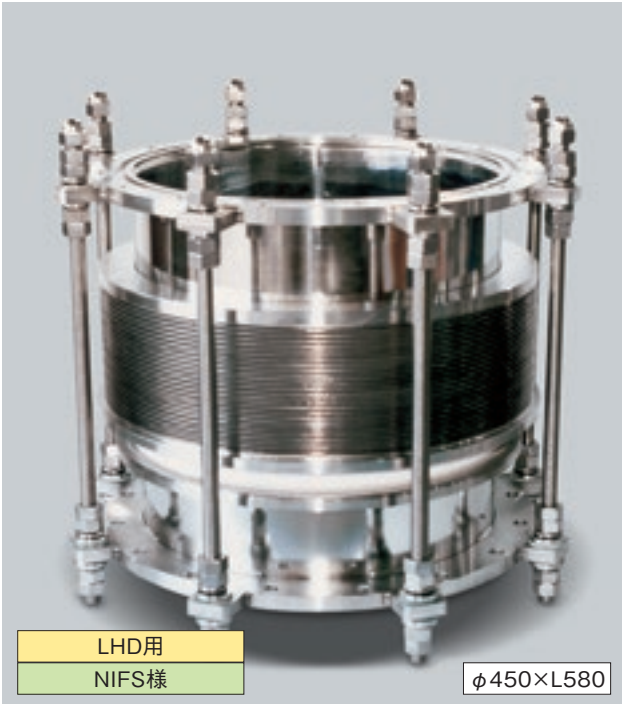

by courtesy of National Institute for Fusion Science
Applicaton: Large Helical Device



by courtesy of Japan Atomic Energy Agency
Applicaton: JT-60



by courtesy of National Institute for Fusion Science
Applicaton: Large Helical Device



Custom-designed Accelerator Tubes

unit : mm



by courtesy of Japan Atomic Energy Agency
Application: Electron Gun



by courtesy of Tsukuba University



by courtesy of Advanced Research Laboratory, Hitachi, Ltd.
Application: Super High Voltage Electron Microscope

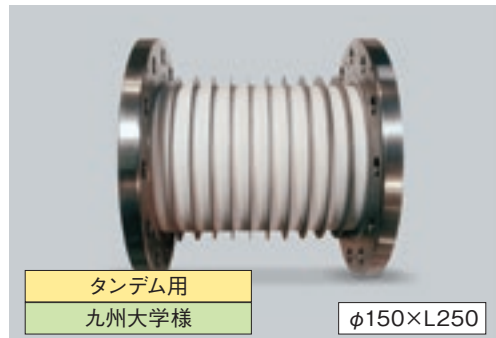

by courtesy of Kyushu University
Application: Tandem Accelerator



by courtesy of Hitachi, Ltd.
Application: Electron Microscope

Custom-designed Sapphire and Silicon Nitride Windows

unit : mm

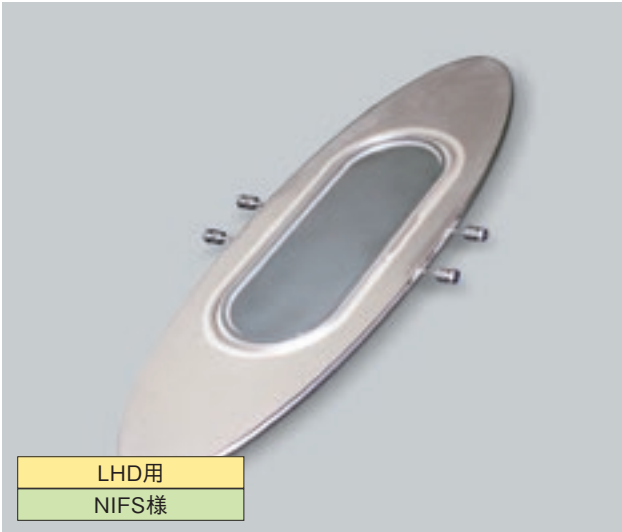

LHD用
NIFS様

by courtesy of National Institute for Fusion Science
Application: Large Helical Device

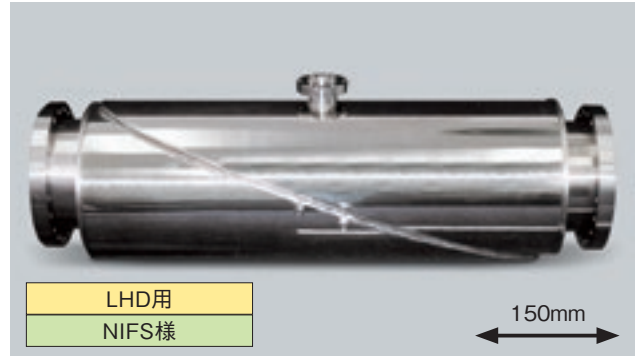

LHD用
NIFS様

150mm

by courtesy of National Institute for Fusion Science
Application: Large Helical Device

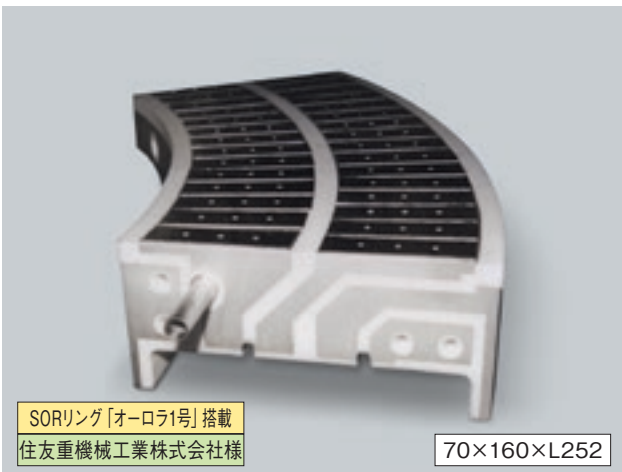

SORリング「オーロラ1号」搭載
住友重機械工業株式会社様

70×160×L252

by courtesy of Sumitomo Heavy Industries, Ltd.
Application: SORring "AURORA"



LHD用
NIFS様

φ180

by courtesy of National Institute for Fusion Science
Application: Large Helical Device



TRIAM-1M用SA窓
九州大学様

114×185×t7

by courtesy of Kyushu University
Application: TRIAM-1M

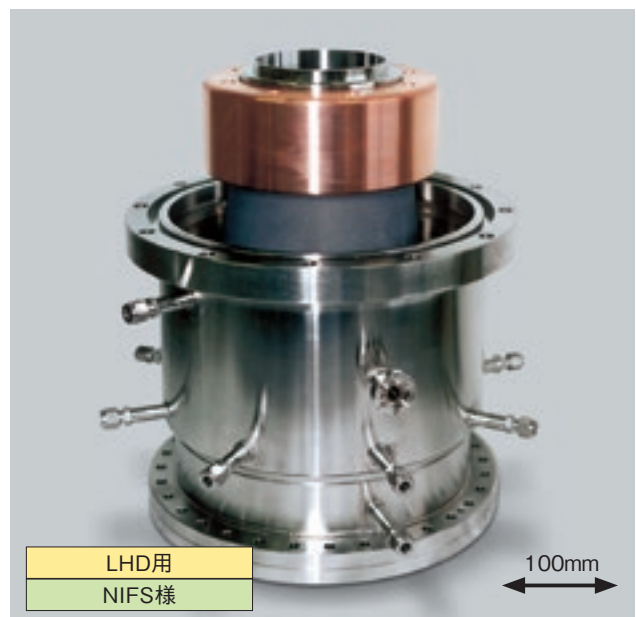

LHD用
NIFS様

100mm

by courtesy of National Institute for Fusion Science
Application: Large Helical Device

Custom-designed Beam Feedthroughs

unit : mm

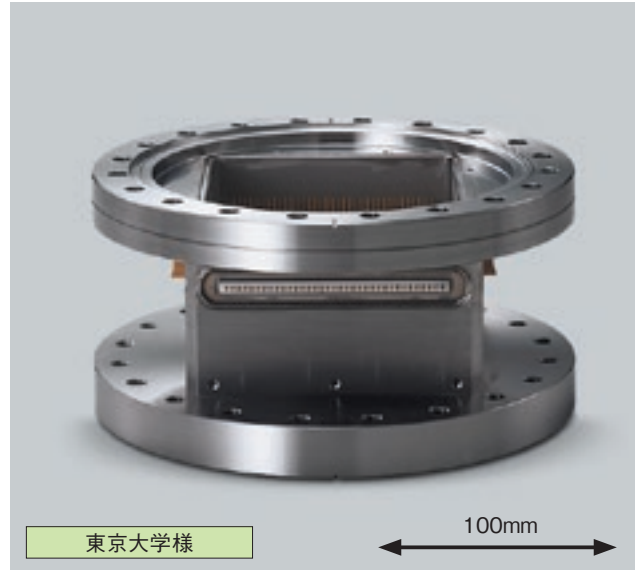

by courtesy of University of Tokyo

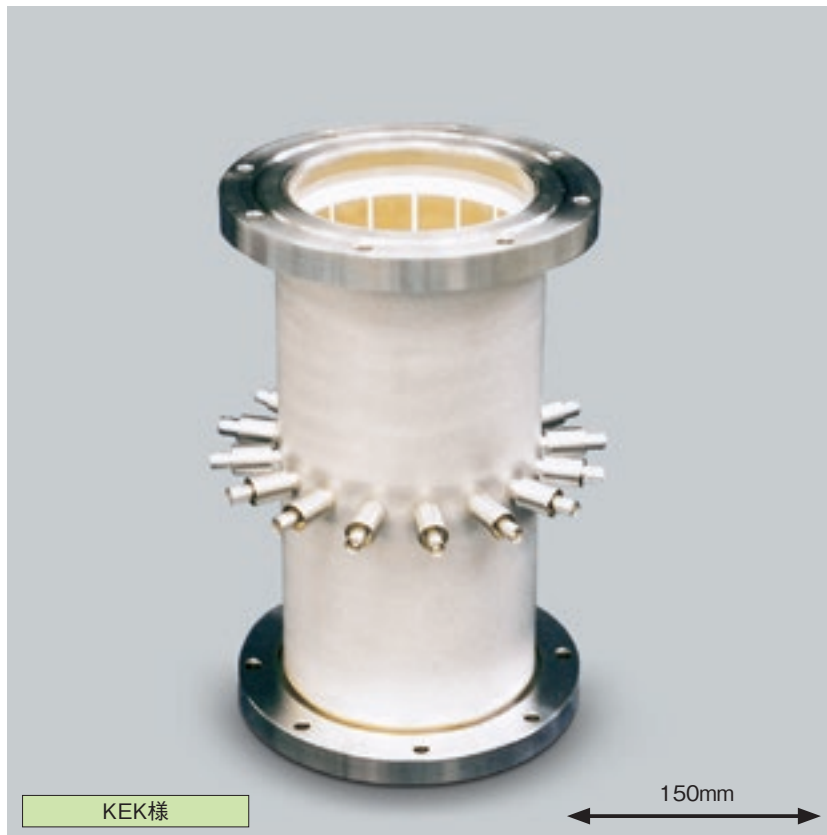

by courtesy of High Energy Accelerator Research Organization

Custom-designed Ion Source Feedthroughs

unit : mm

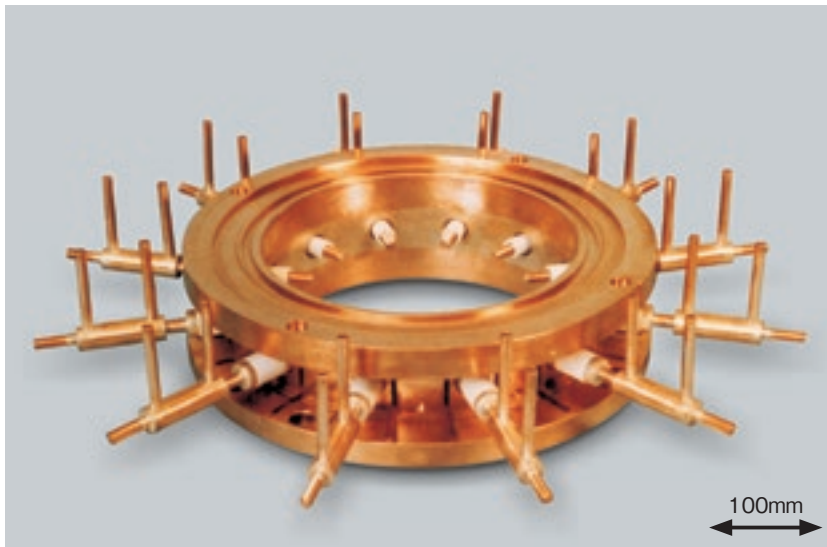
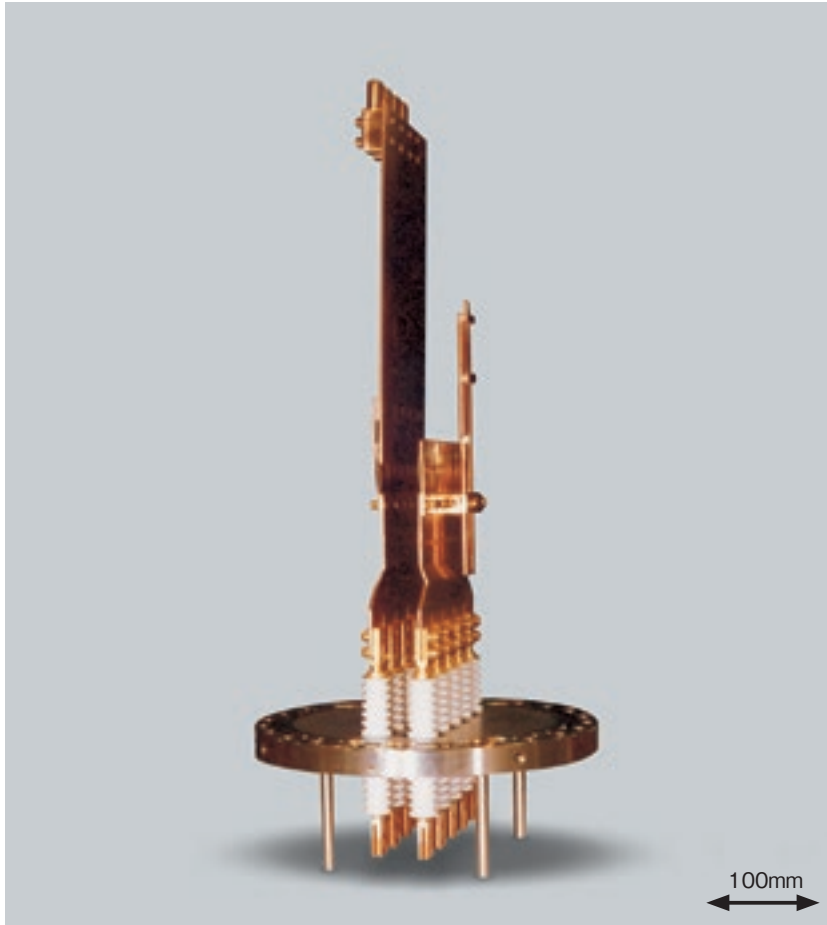

Custom-designed Feedthroughs

unit : mm



by courtesy of High Energy Accelerator Research Organization
Application : S-KEKB



100KV Feedthrough



Custom-designed Feedthroughs and Isolators

unit : mm

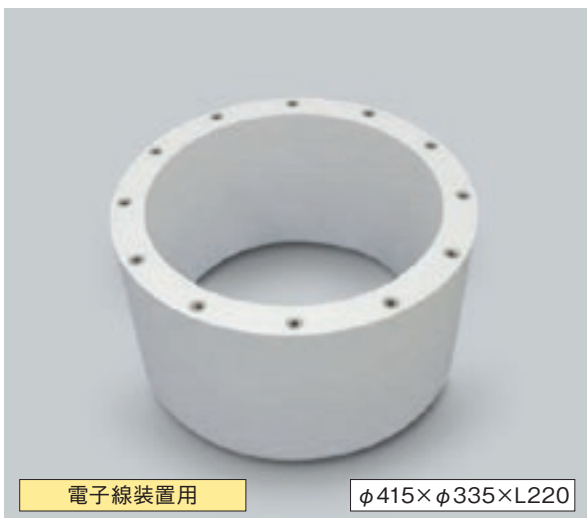

Application: Electron Beam Processing System

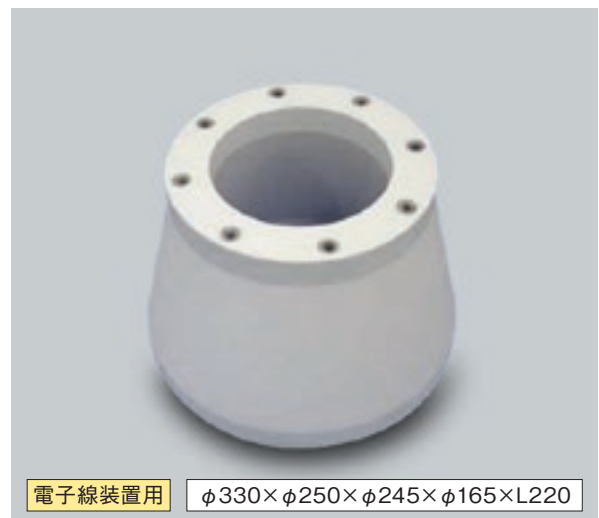

Application: Electron Beam Processing System

セラミックスの特性表

Characteristics of Ceramics

Material Item		ALUMINA (Al ₂ O ₃)						SILICON NITRIDE (Si ₃ N ₄)	SINGLE CRYSTAL SAPPHIRE (Al ₂ O ₃)			
Material Code	New	AO459K	AO473O	AO476O	AO479O	AO479U	AO479M	SN220O	SA100			
	Old	A459	A473	A476	A479	A479U	A479M	SN220	SA100			
Appearance		Dense	Dense	Dense	Dense	Dense	Dense	Dense	Dense			
Color		Russet	White	White	White	White	Ivory	Black	Transparent			
Content (%)		89	92	96	99	99.6	99.5	-	99.99			
Main Characteristics		High Mechanical Strength, High Temperature Resistance, High Frequency Insulation, High Chemical Resistance						High Temperature Strength Wear Resistant Excellent Thermal Shock Resistance Light Weight	High Mechanical Strength High Heat Resistance High Chemical Resistance High Electric Insulation Resistance			
		Good for Metallizing	Good for Metallizing Mechanically Strong	Good Surface Smoothness	Hard and Chemically Stable	High Hardness High Corrosion Resistance Low Dielectric Tangent	High Chemical Resistance					
Main Applications		Magnetron	IC Multi Layer Packages Electrontube Housing	Hybrid IC Substrates	Heat. Corrosion And Wear Resistant Parts	Semiconductor Processing Equipment	Wear Resistant Parts Chemically Resistant Parts Semiconductor Processing Equipment Parts	Internal Combustion Engine Parts Molten Metal Parts Gas Turbine Parts Metal Forming Tool	SOS Substrate Window for High Temperature High Pressure Equipment Construction Parts Parts for Scientific Equipment			
Density (*1)		g/cm ³	JISR 1634	3.6	3.6	3.7	3.8	3.9	3.9	3.2	3.97	
Water Absorption		%	JISC 2141	0	0	0	0	0	0	0	0	
Mechanical Characteristics	Vickers Hardness HV9.807N	GPa	JISR 1610	12.1	12.3	13.7	15.2	15.2	15.7	13.9	a Plane 22.5	
	Flexural Strength 3 P.B.	MPa	JISR 1601	310	340	350	310	380	370	610	a Plane c Axis 690	
	Compressive Strength	MPa	JISR 1608	-	2,300	2,992	2,160	2,530	2,984	3,820	2,940	
	Young's Modulus Of Elasticity	GPa	JISR 1602	280	280	320	360	387	370	290	470	
	Poisson's Ratio	-		0.23	0.23	0.23	0.23	0.23	0.23	0.28	Parallel to Axis c 0.18 Vertical to Axis c	
	Fracture Toughness (SEPB)	MPa · m ^{1/2}	JISR 1607	-	3.5	2.9	3~4	4.3	4.3	5	2.1	
Thermal Characteristics	Coefficient Of Linear Thermal Expansion	40~400°C	×10 ⁻⁶ /°C	JISR 1618	7.0	6.9	7.2	7.2	7.2	7.2	2.6	Parallel to Axis c 7.7 Vertical to Axis c 7.0
		40~800°C		7.9	7.8	7.9	8.0	8.0	8.0	3.2	Parallel to Axis c 8.8 Vertical to Axis c 7.9	
	Thermal Conductivity 20°C	W / (m · K)	JISR 1611	14	18	24	29	32	32	20	42	
	Specific Heat Capacity	J / (g · K)	JISR 1611	0.75	0.78	0.78	0.79	0.77	0.78	0.66	0.75	
Thermal Shock (Put in Water, Temperature Relative Difference Method)	°C	JISR 1648	-	150	150	150	180	180	180	550	180	
Electrical Characteristics	Dielectric Strength		kV/mm		15	16	15	15	14.6	15	10	48
	Volume Resistivity	20°C	Ω · cm	JISC 2141	>10 ¹⁴	>10 ¹⁴	>10 ¹⁴	>10 ¹⁴	>10 ¹⁴	>10 ¹⁴	>10 ¹⁴	>10 ¹⁴
		300°C		10 ¹⁰	10 ¹²	10 ¹⁰	10 ¹⁰	10 ¹³	10 ¹³	10 ¹²	10 ¹²	
		500°C		10 ⁸	10 ¹⁰	10 ⁸	10 ⁸	10 ¹⁰	10 ¹⁰	10 ¹⁰	10 ¹¹	
	Dielectric (1MHz) Constant	-		8.8	9.0	9.4	9.9	10	9.9	-	Parallel to Axis c 11.5 Vertical to Axis c 9.3	
	Dielectric Loss Tangent (1MHz)	(×10 ⁻⁴)		6	6	4	2	<1	1	-	<1	
Loss Factor	(×10 ⁻⁴)		52	54	38	20	-	10	-	-		
Chemical Characteristics	Nitric Acid (60%) 90°C, 24H	(Weight Loss)		-	0.32	0.02	0.10	-	0.01	1.00	≒0.00	
	Sulphuric Acid (95%) 95°C, 24H	mg/cm ²		-	0.65	0.01	0.33	-	0.00	0.40	≒0.00	
	Sodium Hydroxide (30%) 80°C, 24H			-	0.91	0.86	0.26	-	0.00	0.36	≒0.00	

※これらの値はテストピースの測定による参考値です。特性値は製品の形状や使用条件により異なる場合があります。

※The values are typical material properties and may vary according to products configuration and manufacturing process. For more details, please feel free to contact us.

(注1) 密度は見掛密度、かさ密度、共に記載の値となります。

*1: All values for apparent density and bulk density are the same,

Precision Shaping and Machining

形状と加工精度

京セラは、独特のセラミックス精密機械加工技術により、原料から成形された生素材を切削加工、あるいは焼成後に研削、ラッピング加工を行い、要求された複雑な形状をしかも高精度に加工しています。

このようにして加工された京セラのセラミックス機械加工製品は、超高精度を要求される OA 機器の摺動部品をはじめとして、一般構造用部材、精密治工具、電磁ならびに化学薬品中で摺動する耐摩耗、耐薬品部品等に素晴らしい性能を発揮しています。

Using Kyocera's unique ceramic precision machining technology, the formed material is cut, ground and lapped after sintering to the required complex shapes with high precision. These products are used for their unrivaled performance in OA sliding parts with ultrahigh precision, general structural members, precision jigs and tools, and also in wear and chemical resistant parts sliding in electromagnetic fields and chemical solutions.

機械加工による寸法精度 Dimensional Precision Achieved by Machining

セラミックスに金属部品と同様な寸法精度の加工が要求される場合、下表のような公差まで加工しています。形状、寸法等、表で適用できない範囲は別途ご相談ください。

When dimensional precision equivalent to that for metal parts is required for machined ceramics, Kyocera can achieve the tolerances shown in the table below. If greater tolerances in shapes or dimensions are required, please contact us.

■加工寸法精度 (指示なき単位はmm) Machining Dimensional Precision (data are in mm unless otherwise specified)

①セラミックブロックおよび板類の研磨品 Ground ceramic blocks and plates

項目 Parameter	公差 Tolerance 大きさ Dimension	
	普通公差 Standard Tolerance	φ(SQ)5~φ(SQ)30
平行度 Parallelism	0.02	0.05
平坦度 Flatness	0.01	0.03
表面粗さ Surface Roughness	1.5μRa	1.5μRa
鏡面研磨 Mirror Polishing	0.2μRa	

②丸棒、角棒 Round and Square Bars φ100 (SQ100) × 100L

項目 Parameter	公差 Tolerance	普通公差 Standard Tolerance
真円度 Roundness	0.01	0.01
直角度 Perpendicularity	0.01 (30')	0.01 (30')
真直度 Straightness	0.05/100	0.05/100
表面粗さ Surface Roughness	1.5μRa	1.5μRa

■精密加工品 Precision Machined Products

京セラ独自の加工法により、さらに精密な加工も可能です。精密加工の精度は形状、材質に左右されるため、特に実施例を下表に示します。

Ultra-precision is possible with Kyocera's unique techniques. Precision machining is affected by the shape and material. Some practical applications are shown in the table below.

加工例 Example of Machining	寸法 Dimensions	材質 Material	寸法公差 Dimensional Tolerance (μm)	真円度 Roundness (μm)	真直度 Perpendicularity Straightness (μm)	表面粗さ Surface Roughness (μRa)
内径加工例 Inner Diameter	φ30×L20	AO4790	± 3	0.3	0.3	0.3
外径加工例 Outer Diameter	φ44×L20	AO4790	± 1	0.3	0.3	0.3
板状品加工例 Plate	φ100×T5	AO4790	± 1	平行度 0.3	平行度 1	0.1

■表面粗さ (アルミナの例) Surface Roughness (Alumina)

①無研磨 As fired (3μRa)



②研削 Ground (1μRa)



③ラッピング Lapped (0.4μRa)



④ポリシング Polished (0.2μRa or less)

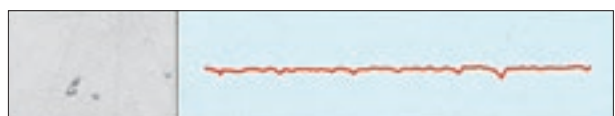

Materials Comparison Chart

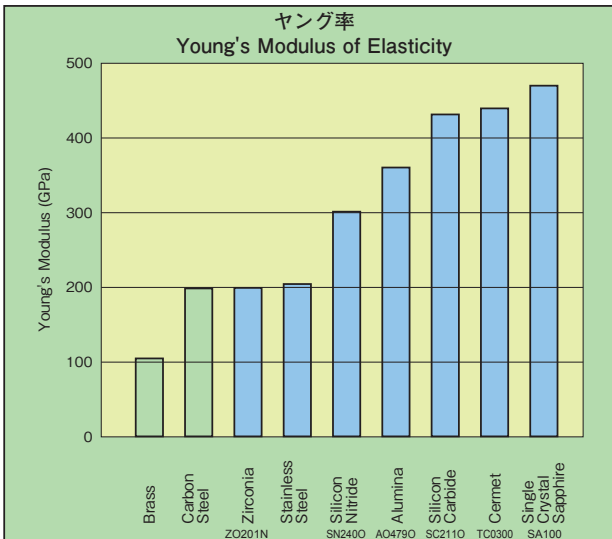
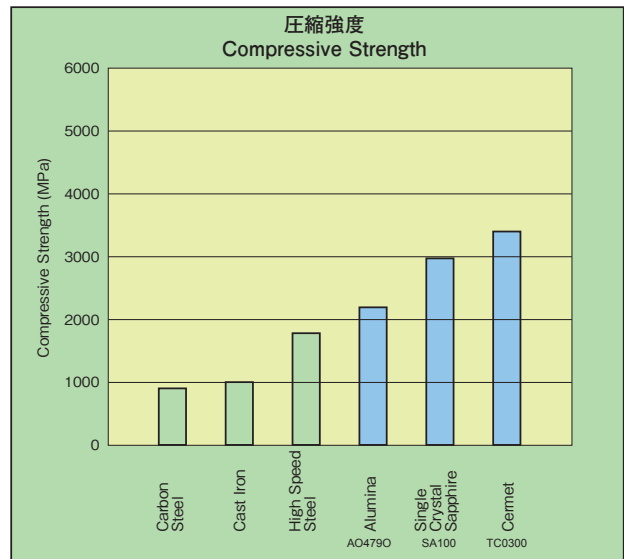
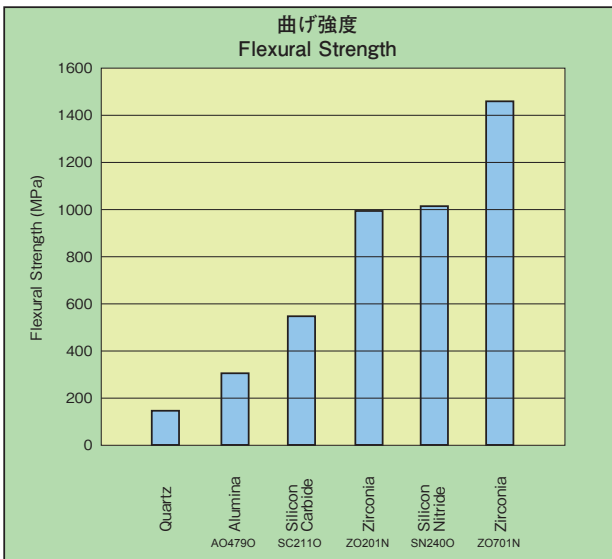
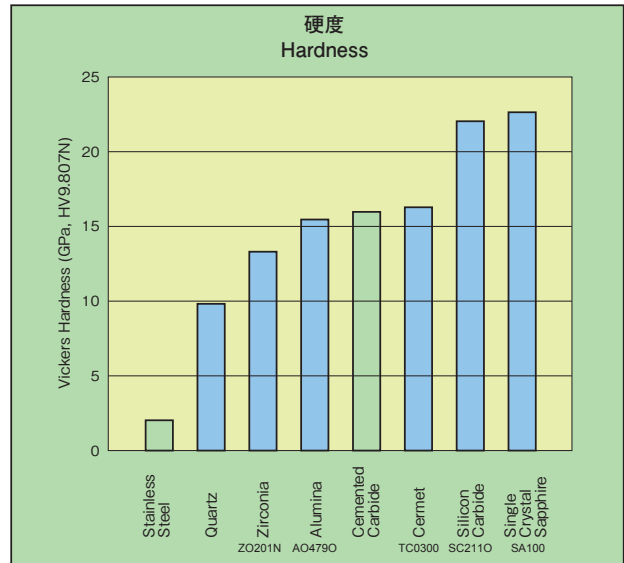
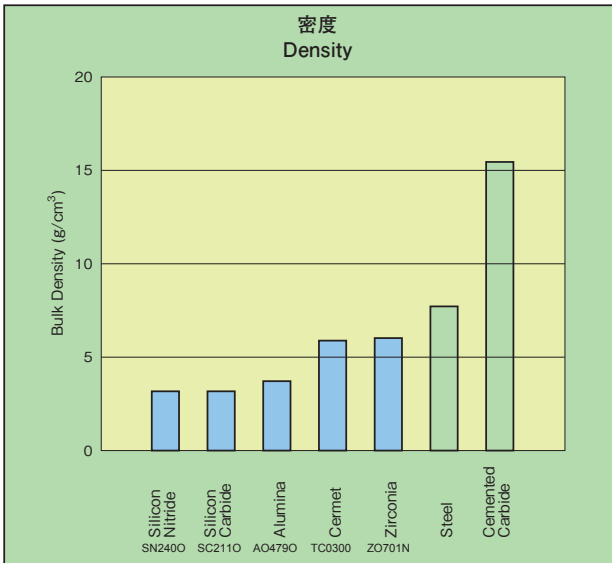

Materials Comparison Chart

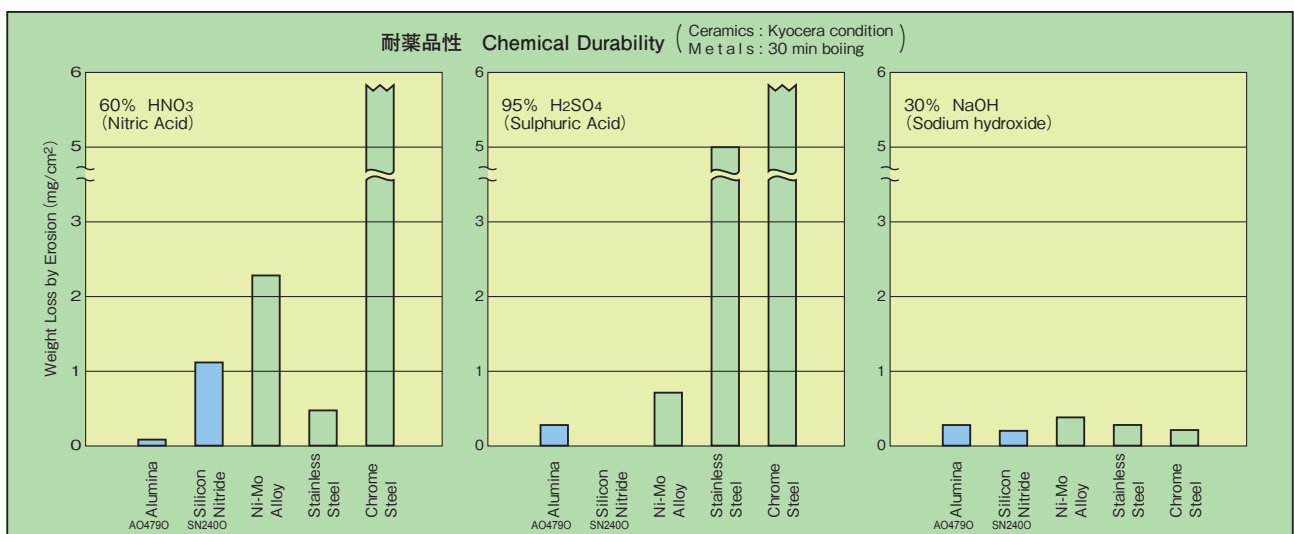
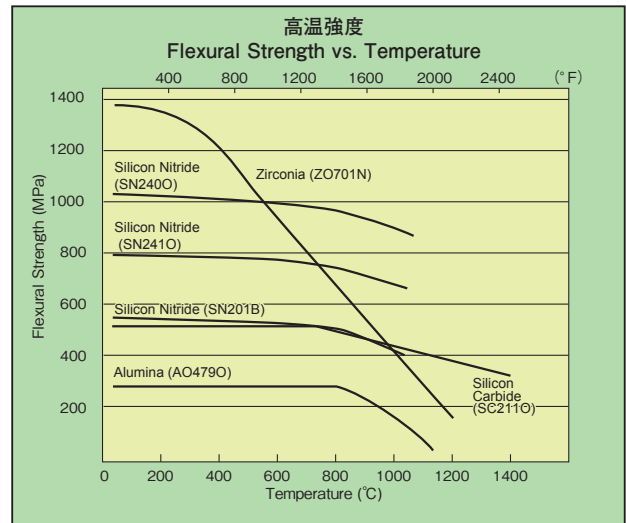
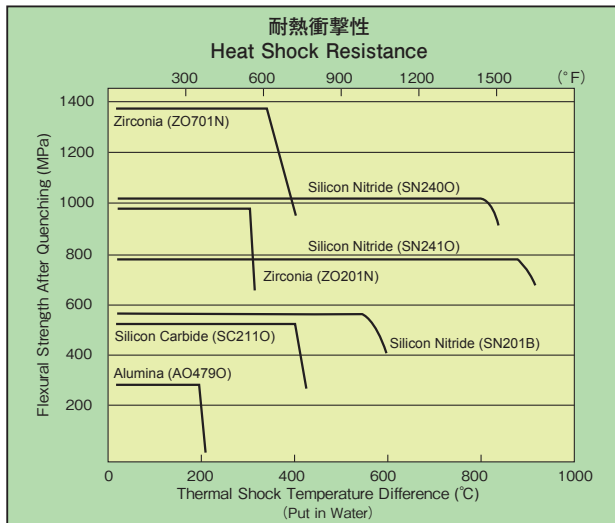
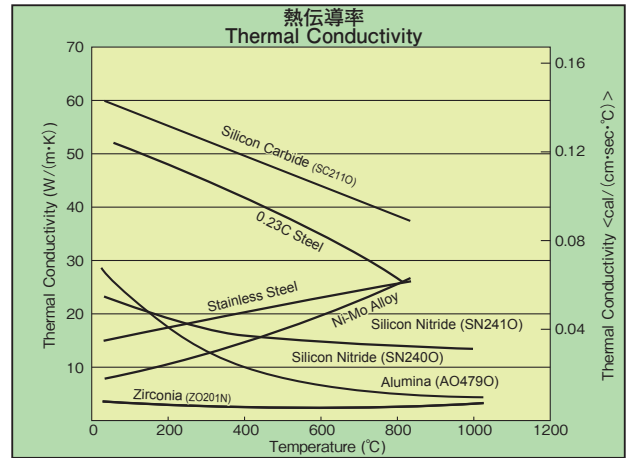
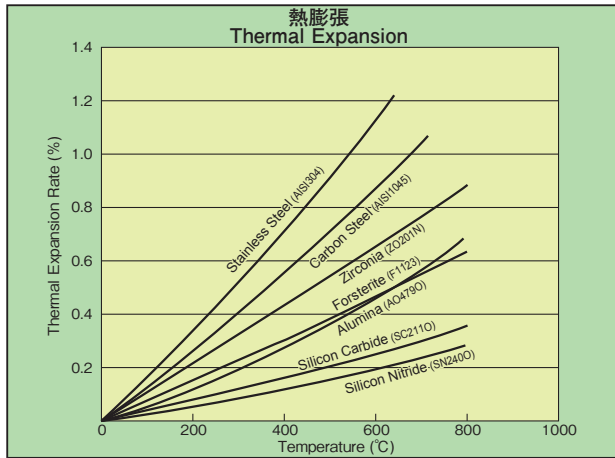

換算表 (Unit Conversion Table)

■ 応力 (Stress)		
MPa or N/mm ²	kgf/mm ²	psi (=lbf/in ²)
1	1.020 × 10 ⁻¹	1.450 × 10 ²
9.807	1	1.422 × 10 ³
6.895 × 10 ⁻³	7.031 × 10 ⁻⁴	1

■ 熱伝導率 (Thermal Conductivity)

W/(m·k)	kcal/(m·h·°C)	cal/(cm·sec·°C)
1	8.600 × 10 ⁻¹	2.389 × 10 ⁻³
1.163	1	2.778 × 10 ⁻³
4.186 × 10 ²	3.600 × 10 ²	1

接合金属の特性表 (代表例)

Characteristics of Material (Example)

			Fe-Ni-Co Alloy	Alloy42	Ni	Mo	Al	OFHC (COPPER)	STEEL	SUS304	SUS316	Cu/W-10	Cu/W-15	Ti
Composition by Weight(%)			Fe54 Co17 Ni29	Fe58 Ni42	Ni99.0 min	Mo99.9	Al99.4	Cu99.96	Fe99.2	Fe67 Cr20 Ni10	Fe62 Cr18 Ni14	Cu10 W90	Cu15 W85	Ti99.1
Application			1/0pin Lead Frame Seal Ring	1/0pin Lead Frame Seal Ring	Lead Frame	Heat Sink	Connector	Heat Sink	Flange Sleeve	Flange Sleeve	Flange Sleeve	Heat Sink	Heat Sink	Flange Sleeve
Bulk Density			8.3	8.2	8.8	10.3	2.7	8.9	8.7	7.8	7.98	17.3	16.4	4.51
Hardness Rockwell-B			70-85	60-80	50-80	54-58	-	12-43	55	90	90	105	103	-
Mechanical Characteristics	Tensile Strength	Mpa Kpsi	490-510 71-74	471 64	343-549 50-80	686-980 100-142	167-382 24-55	206 30	392 57	588 84	588 84	490 71	529 77	- -
	Elongation	%	Brazed 35	Brazed 35	Brazed 35	5	40	40	35	60	60	-	-	-
	Young's Modulus of Elasticity	Gpa Mpsi	137 20.0	147 21.4	200 29.0	324 47.1	69 10.0	117 17.0	196 28.4	193 28.1	193 28.1	333 48.5	314 45.7	106 -
Thermal Characteristics	Coefficient Of Linear Thermal Expansion	$\times 10^{-6}/^{\circ}\text{C}$ 20-500°C	5.7-6.2	7.5-8.5	15	5.7	23 (20-100°C)	18.3	13.9	18.7	16.0	6.0	6.5	8.4
	Thermal Conductivity	$\frac{\text{W}}{\text{M}\cdot\text{K}}$ 20°C 100°C	16.7 18.4	14.7 16.7	84.1 82.9	155 147	151 -	391 393	58.6 -	- 16.3	- 16.3	170 -	190 -	- 17.2
	Specific Heat	Cal/g°C	0.105	0.120	0.130	0.060	0.210	0.090	-	0.120	0.120	0.05	0.07	0.124
Electrical Characteristics	Volume Resistivity	$\mu\Omega\cdot\text{cm}$ 20°C	48	58	6.8	5.8	2.7	1.7	12	72	74	-	-	55
	Electrical Conductivity	%IACS	-	-	-	-	64	100	18	2.4	-	26	34	3.1

※これらの値は参考値です。特性値は製品の形状や使用条件により異なる場合があります。

※The values are typical material properties and may vary according to products configuration and manufacturing process.

メタライズ技術、各種素材と加工

Metallization Technologies And Materials

Mo-Mn メタライズ法

Mo-Mn METALLIZATION

アルミナ	ALUMINA (Al ₂ O ₃)
サファイア	SAPPHIRE (Al ₂ O ₃)

活性金属法

ACTIVE METAL BONDING

アルミナ	ALUMINA (Al ₂ O ₃)
サファイア	SAPPHIRE (Al ₂ O ₃)
窒化ケイ素	SILICON NITRIDE (Si ₃ N ₄)
窒化アルミ	ALUMINUM NITRIDE (AlN)

接合金属

BONDING METALS

MAGNETIC METALS (磁性)	NON-MAGNETIC METALS (非磁性)
29% Ni17% CoFeAlloy Ni	Titanium Gold(Au)
42% NiFeAlloy 430Stn.Stl.	Tantalum Silver(Ag)
52% NiFeAlloy Monel*	Inconel Copper(Cu)
	Niobium 70% Cupro Nickel
	Tungsten Aluminum(Al)
	Molybdenum Aluminum Alloy
	304Stn.Stl.

* Monel and Inconel are registered trademarks of the International Nickel Co.,Inc.

ろう材

BRAZING MATERIALS

ろう材 Brazing Material	融点 Melting Temp.(°C)	成分 Composition
Silver Copper	780	72%Ag-28%Cu
Gold Copper	990	37%Au-63%Cu
Gold Nickel	950	82%Au-18%Ni
Aluminum Alloy	580	Al-Si-Mg
Gold	1064	99.9%Au
Silver	961	99.9%Ag
Copper	1084	99.9%Cu

室温における各種真空用材料のガス放出速度

COMPARISON OUTGAS SPEED OF VARIOUS MATERIAL

真空用材料 Material	室温におけるガス放出速度 OUTGAS SPEED at RT[Torr·l/cm ² sec]	
	After Vacuum at RT	24hrs after Baking(°C)
セラミックス CERAMIC	10 ⁻⁹ ~10 ⁻⁸	10 ⁻¹⁵ ~10 ⁻¹⁴ (400)
ナイロン NYLON	2×10 ⁻⁸ (51hrs after Vacuum)	4×10 ⁻¹¹ (120)
フッ素ゴム FKM	7×10 ⁻⁸ (51hrs after Vacuum)	1.3×10 ⁻⁹ (200)
フッ素樹脂 PTFE	10 ⁻⁸ ~10 ⁻⁷	小さい (Less) (250)
ガラス GLASS	10 ⁻⁹ ~10 ⁻⁸	10 ⁻¹⁵ ~10 ⁻¹⁴ (400)
金属 METAL	10 ⁻⁹ ~10 ⁻⁸ (50hrs after Vacuum)	10 ⁻¹⁵ ~10 ⁻¹⁴ (400)

セラミックスと金属の基本的な接合構造

Basic Design of Ceramic-To-Metal Bonding

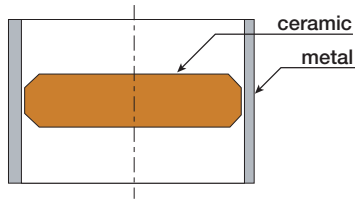

(1) アウトサイドシール Outside seal

セラミックスに金属による圧縮応力がかかるため信頼性の高い構造です。
Highly reliable construction because compression stress from the metal is applied to the ceramics.

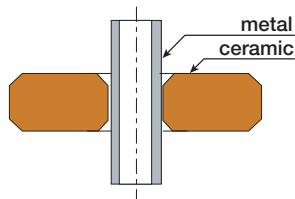

(2) インサイドシール Inside seal

内側の金属の熱膨張係数に注意する必要があります。セラミックスより大きい場合、セラミックスが割れることがあります。
It is necessary to pay attention to the coefficient of thermal expansion of the metal. It may be cracked if the coefficient of thermal expansion of the metal is higher than that of the ceramics.

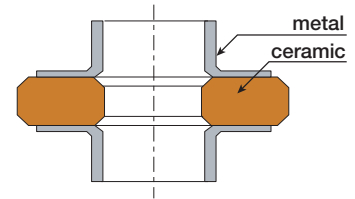

(3) バットシール Butt seal

組立が容易な構造
Easy-to-assemble construction.

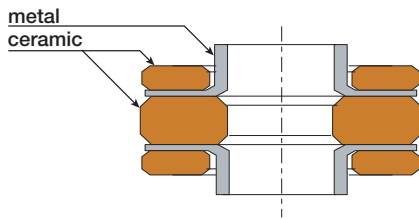

(4) バックアップリング付バットシール Butt seal with back-up ring

組立が容易な構造で応力を分散させるためにバックアップリングを用いています。
Easy-to-assemble construction. A back-up ring is used to distribute the stress.

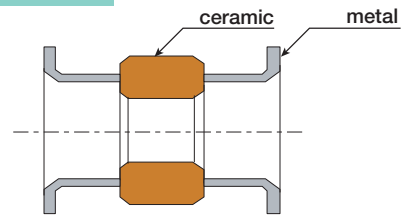

(5) エッジシール Edge seal

接合面の平面度が必要な構造です。平面度が悪いと信頼性が低下します。
Flatness is needed to bond the surfaces. If the flatness is not good, the reliability will be poor.



KYOCERA Corporation

Corporate Fine Ceramics Group

J P: <https://www.kyocera.co.jp/prdct/fc/>

Product Inquiries→



EN: <https://global.kyocera.com/prdct/fc/>

Product Inquiries→



The contents of this catalog are subject to change without prior notice for future improvement.
Application and the using conditions are required to be consulted when considering to purchase.

Duplication or reproduction of any part of this brochure without approval is prohibited.

© 2024 KYOCERA Corporation 037/011/2403 Printed in Japan